

The **pNeuton** Ventilator is under US patent protection.
(Patent # 6,591,835)

pNeuton is a Registered Trademark of the Airon Corporation

Copyright © 2011 by Airon Corporation

pNeuton[®] **Transport Ventilator**

Model S

Operators Manual



Manufactured by:

Airon Corporation
751 North Drive
Unit 6
Melbourne, Florida 32934
USA

Tel: 888-448-1238 (toll free USA & Canada)
+1-321-821-9433
Fax: +1-321-821-9443

www.AironUSA.com



Intertek

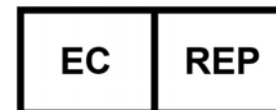

EMERGO EUROPE
Prinsessegracht 20
2514 AP The Hague
The Netherlands

REF 97001

CD-S-005 Rev K
Released 1 Jan 2019

Table of Contents

Section 1. General Description	1-1
Section 2. Warnings, Cautions, Notes	2-1
Warnings	2-1
Cautions	2-3
Notes	2-4
Indications for Use	2-6
Contraindications	2-6
Medical Symbol Key	2-7
Section 3. Controls and Patient Safety Systems ..	3-1
Front Panel	3-1
Rear Panel	3-3
Unique Device Identifier	3-4
Internal Patient Safety Systems	3-5
Section 4. Operating Instructions	4-1
Ventilator Set-up	4-1
Operational Verification	4-2
Patient Ventilation	4-3
Interrelationship of Volume and Rate Controls ..	4-4
Oxygen Control	4-5
Hypobaric Operation	4-5
Section 5. Patient Circuit	5-1
Adult / Pediatric Circuit	5-1
Ventilator Connection	5-2
Single-Use only Devices/Accessories	5-3
Section 6. Accessories	6-1
Section 7. Theory of Operation	7-1
Pneumatic System Diagram	7-1
Pneumatic System Description	7-2
Tidal Volume and Rate Control System	7-3

Mandatory Breath Pressure Control System	7-5
CPAP Demand Flow Breathing System	7-5
Oxygen Delivery System	7-6
MRI Compatibility	7-9
Low Gas Supply Alarm	7-10
Section 8. Troubleshooting	8-1
Section 9. Cleaning and Maintenance	9-1
Cleaning the Ventilator	9-1
Cleaning / Disinfecting the Patient Circuit	9-1
Routine Maintenance	9-1
Factory Preventative Maintenance.....	9-1
Section 10. Specifications	10-1
General Description	10-1
Ventilator System Performance	10-1
Alarm System	10-2
Environmental and Physical Characteristics	10-2
Power Sources	10-3
Section 11. Limited Warranty	11-1
Section 12. Index	12-1

pNeuton Transport Ventilator

Section 1: General Description

pNeuton (pronounced "new-ton") is a small, lightweight transport ventilator designed for use on patients from pediatric to adult in size, 23 kg or greater. It is a time cycled, flow limited ventilator providing Intermittent Mandatory Ventilation (IMV). In this mode of ventilation, an adjustable respiratory rate and tidal volume are delivered to the patient. The patient is allowed to breath spontaneously between the mandatory breaths with minimal work of breathing. A built-in PEEP / CPAP system can be set to provide expiratory positive pressure. The delivered oxygen is adjustable between 65 and 100 percent, with oxygen as the driving source gas.

pNeuton is a pneumatic ventilator. Electrical power is not required for patient ventilation. **pNeuton** has been specifically designed for patient support during transport and non-critical care unit mechanical ventilation. It may be used during intra and inter-hospital transport, in aircraft, on ambulances, in emergency rooms, MRI and other radiology suites.

Section 2: Warnings, Cautions, Notes

The **pNeuton** Ventilator is intended for use by properly trained personnel under the direct supervision of licensed medical Physician or Practitioner only. Personnel must become thoroughly familiar with this Operators Manual prior to using the **pNeuton** Ventilator on a patient.

As used in this manual, the following terms mean:

- Warning:** Indicates the possibility for injury to the patient or the operator
- Caution:** Indicates the possibility of damage to the device
- Note:** Places emphasis on an operating characteristic

Warnings

This manual serves as a reference. The instructions in this manual are not intended to supercede the physician's instructions regarding the use of the **pNeuton** Ventilator.

The operator should read and understand this entire manual before using the **pNeuton** Ventilator.

 **DO NOT** use the **pNeuton** Ventilator in conjunction with anesthetics or in contaminated (hazardous, explosive) atmospheres. Only compressed oxygen may be used.

 **DO NOT** use conductive (anti-static) patient breathing circuits. The only approved patient circuits for use with **pNeuton** Ventilator are the Airon circuits listed in Section 5 of this manual. Any other patient circuit should **NOT** be used and may lead to patient harm.

 The Operational Verification tests as described in this manual (Section 4) must be performed prior to connecting a patient to the ventilator. If the ventilator fails any of the tests it must be removed from clinical use. **DO NOT** return the unit to clinical use until all repairs have been completed by an Airon approved repair facility and all operational verification tests are acceptable.

 The **pNeuton** Ventilator has been designed for use on adult and pediatric patients. The **pNeuton** cannot deliver operator adjusted tidal volumes less than 360 ml. **DO NOT use the pNeuton Ventilator on neonatal or infant patients, or small children.**

To protect the patient from high airway pressures, insure that the Peak Pressure control is adjusted appropriately.

 Due to the design of the ventilator (see Section 7 - Theory of Operation) the Tidal Volume and Respiratory Rate controls are interdependent. The Tidal Volume control is a calibrated control. The Respiratory Rate control is calibrated for a set tidal volume between 500 ml and 900 ml. Lower tidal volumes will have higher rates, higher tidal volume will have lower rates. Once the tidal volume is set, it will not vary as the respiratory rate is changed. **However, if the Tidal Volume control setting is changed the respiratory rate may change.** Always recheck the patient's mandatory breath rate after changing the tidal volume to assure the patient is receiving the proper respiratory rate.

 The **pNeuton** Ventilator does not have a patient disconnect alarm. If the patient becomes disconnected from the ventilator there will be no audible or visual alarm to indicate this condition. Always observe the patient while providing ventilation. If this is not possible, attach an external monitor that will indicate a patient disconnect.

 The **pNeuton** Ventilator is not intended for use under hyperbaric pressure conditions. If used in these conditions tidal volume delivery will significantly decrease. Careful patient monitoring of tidal volume with a hyperbaric compatible external spirometer is mandatory.

 The **pNeuton** Ventilator is MRI Conditional up to 3 T (see Notes section below). While tests show that the ventilator functions at the bore of the MRI unit, Airon Corporation does not recommend that the ventilator be clinically used at or within the bore of MRI scanners. A **minimum** proximity of 12 inches (0.3 meter) from the bore should be used. In addition, safe MRI practice calls for all devices used in the proximity of a MRI scanner, including **pNeuton**, be anchored to prevent inadvertent movement.

The Low Gas Supply Alarm will occur if the driving gas supply drops below safe levels (30 psi, 200 kPa). The alarm activates as long as driving gas is available or until supply pressure returns to normal. The alarm will only activate for a very short period of time if the gas supply abruptly ceases as can happen if the supply gas becomes disconnected. Always insure that the supply gas is secure and operating at the proper pressure.

Cautions

 **DO NOT** attempt to service the unit. Service may only be performed by Airon Corporation authorized engineers. The Preventative Maintenance program requires a general service and calibration every two years. Only original manufacturer parts and accessories should be used.

Any attempts to modify the hardware of this device without the express written approval of Airon Corporation will void all warranties and liabilities.

Do not immerse the **pNeuton** Ventilator or allow any liquid to enter the case or the inlet filter. Clean as directed in Section 9, Cleaning and Maintenance.

Notes

In the USA, the **pNeuton** Ventilator is a restricted medical device intended for use by qualified medical personnel under the direction of a physician.

During the transport of patients it is recommended that an alternate source of ventilation be available in the event of driving gas supply failure or ventilator malfunction.

 The ventilator will operate normally at altitudes up to 15,000 feet. Changes in altitude will not effect pressure settings but will cause the delivered tidal volume to increase and the respiratory rate to decrease as altitude increases. To compensate for the effect of changing altitude on tidal volume and respiratory rate, use an external spirometer to verify tidal volume accuracy.

The **pNeuton** Ventilator is MRI Conditional. Non-clinical testing demonstrated that the **pNeuton** Ventilator is MR Conditional and can be used in the MRI environment according to the following conditions:

- Static magnetic field of 3-Tesla or less
- Maximum spatial gradient magnetic field of 720 Gauss/cm

IMPORTANT NOTE: This product is intended for use within the MRI environment (e.g., in the MR system room). It should not be utilized directly inside of the MR system (e.g., inside of the bore of the scanner), during its

operation (i.e., scanning). As such, the assessment of magnetic field interactions for this product specifically involved evaluations of translational attraction and function in relation to exposure to a 3-Tesla MR system only.

Airon recommends that users perform similar tests in their MRI scanner prior to patient use.

Special note on the presence of latex: The components, devices, accessories, and packaging that make up the **pNeuton** Ventilator system do not contain any dry natural rubber or natural rubber latex, which may cause allergic reactions.

Special note on the presence of di (2-ethylhexyl) phthalate (DEHP): The components, devices, accessories, and packaging that make up the **pNeuton** Ventilator system do not contain any phthalates which are classified as carcinogenic, mutagenic or toxic to reproduction, of category 1 or 2, in accordance with Annex I to Directive 67/548/EEC.

Additional Warnings, Cautions, and Notes are located throughout this manual.

Indications for Use

The **pNeuton** Ventilator is intended for continuous mechanical ventilation of patients in the following patient populations and use locations:

Patient population - adult / pediatric patients 23 Kg and greater who require the following general types of ventilatory support:

- positive pressure ventilation delivered invasively (via an ET tube) or non-invasively (via a mask)
- CMV and IMV modes of ventilation
- with or without PEEP / CPAP
- with oxygen or a mixture of air and oxygen

The ventilator is suitable for use in:













- Pre-hospital transport applications including accident scene, emergency rescue vehicles
- Hospital ICU transport applications including emergency, radiology, surgery, post-anesthesia / recovery and MRI departments
- Air transport via helicopter or fixed wing

Contraindications

The following conditions contraindicate the use of the **pNeuton** Ventilator:

- Patients undergoing procedures with flammable anesthetic gasses
- Patients undergoing hyperbaric treatment
- Infants and neonatal patients requiring tidal volumes less than 360 ml.

Airon's Medical Symbol Key

	Consult Instructions of Use
	CE Marked
	Authorized Representative in European Community
	Model (Part) Number
	Lot Number
	Do Not Reuse
	MRI Conditional (3 T)
	Manufacturer
	Manufactured Date
	Use By Date
	Keep Dry
	Caution, serious injury or device damage may occur by disregarding the instructions accompanying this warning symbol.

Section 3: Controls and Patient Safety Systems

Front Panel

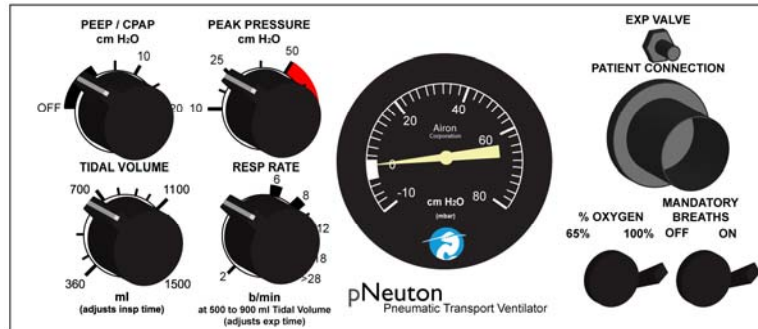

Pressure gauge, patient circuit pressure



Peak Pressure control of mandatory breaths, calibrated, range 10 to 75 cm H₂O



PEEP / CPAP control, calibrated, range 0 to 20 cm H₂O

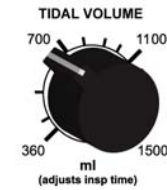

Tidal Volume control, calibrated, range 360 to 1,500 ml

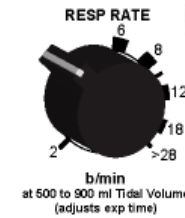

Respiratory Rate control, calibrated at 500 to 900 ml tidal volume, range 2 to 50 bpm dependent on tidal volume setting

MANDATORY BREATHS
On Off



Mandatory Breath control, turns on or off mandatory breath system

% OXYGEN
65% 100%



Oxygen control, select either 100% or 65%

PATIENT CONNECTION



Patient Circuit connection, see section 5 for a complete description of the patient circuit and its attachment to the front panel

EXP VALVE

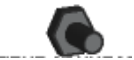

Expiratory Valve connection

Rear Panel

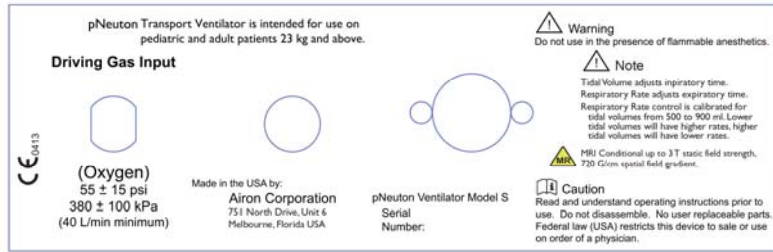

Driving Gas Input

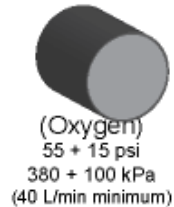

Driving Gas Input (oxygen), DISS connection, requires 55 ± 15 psi (380 ± 100 kPa), (40 liter/minute minimum)



Alarm, Low driving gas



Ambient Air Inlet filter

Unique Device Identification (UDI)

Pursuant to the U.S. FDA Unique Device Identification (UDI) Rule, each device must bear a UDI code. The UDI for **pNeutron** Ventilator is located under the “Serial Number:” labeling, in plain text, on the back panel of the device. The UDI code consists of one Device Identifier (DI) and potentially four Production Identifiers (PI). Therefore, UDI = DI+PI. Production identifiers are required if the information appears on the product (box) label. The UDI on the product (box) label appears in both plain text and machine-readable format. The numbers in the parentheses indicate different parts of the UDI, as applicable to the device:

- (01) Device Identifier
- (10) Batch / Lot Number
- (11) Manufacturing / Production Date
- (17) Expiration Date
- (21) Serial Number

The format for Manufacturing / Production date and Expiration date within the UDI code is: YYMMDD

- YY = tens and units of the year (e.g. 2014 = 14)
- MM = number of the month (e.g. January = 01)
- DD = number of the day (e.g. third day = 03)
- January 03, 2014 = 140103

An example UDI for the **pNeutron** Ventilator is as follows:

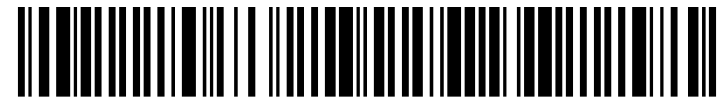

(01)00853678006016(21)S0000

Device Identifier = 00853678006016

Serial Number = S0000

The Device Identifier portion of the code may be entered into AccessGUDID to obtain information about the product.
<http://accessgudid.nlm.nih.gov/>

Internal Patient Safety Systems

The ventilator has several internal safety systems. These systems ensure patient safety in the event of ventilator malfunction.

High Pressure Release

The patient circuit peak pressure is adjustable using the Peak Pressure control. This control can be set from 10 to 75 cm H₂O. The factory preset value is 50 cm H₂O. In addition to this control, there is an internal safety pressure release valve. This valve will automatically limit circuit pressure to approximately 80 cm H₂O, regardless of the setting of the Peak Pressure control.

Anti-Suffocation System

An internal safety system will allow the patient to breathe on his or her own in the event of ventilator malfunction. At approximately 2 cm H₂O negative pressure an internal valve will open allowing unimpeded ambient air to enter the patient circuit for the patient. This system is always available to the patient, irrespective of control settings, including PEEP / CPAP.

Low Gas Supply Pressure Alarm

Whenever the driving gas supply pressure drops below the safe operating pressure an internal pneumatic audible alarm will sound. This low pressure alarm will begin to sound when the source gas pressure drops below 30 psi (200 kPa). The alarm will continue to sound until all pressure has been lost in the system or when pressure is re-established to at least 35 psi (250 kPa).



WARNING: The Low Gas Supply Alarm will only activate for a very short period of time if the gas supply abruptly ceases as can happen if the supply gas becomes disconnected. Always insure that the supply gas is secure and operating at the proper pressure.

Section 4: Operating Instructions

Ventilator Set-up

The following equipment is needed:

1. **pNeuton** Ventilator with breathing circuit (see Section 5 for a list of compatible circuits.)
2. Test lung, (1 Liter rigid wall, Airon Part # 21002 suggested)
3. Spirometer
4. Watch

When ready:

1. Attach breathing circuit to ventilator following instructions in the Operators Manual.
2. Attach the test lung to the patient side of the breathing circuit.
3. Set the controls as follows:
 - a. **Mandatory Breath** control to On
 - b. **Oxygen %** to 65%
 - c. **PEEP / CPAP** to Off
 - d. **Peak Pressure** to 50 cm H₂O
 - e. **Tidal Volume** to 700 ml
 - f. **Respiratory Rate** to 12 bpm
4. Attach ventilator Oxygen Input on rear panel of the ventilator to a high pressure oxygen source and turn on the oxygen.

NOTE: The ventilator will begin operation at the above settings when the oxygen is turned on.

Operational Verification

Verification Step	Acceptable Range	Result
Attach a spirometer to the expiratory valve using the elbow included in the circuit packaging After 3 breaths measure the delivered tidal volume.	700 ± 70 ml	Pass / Fail
Count the respiratory rate with a stopwatch. Measure the number of breaths in one minute.	12 ± 2 breaths per minute	Pass / Fail
Remove the test lung and occlude the patient connection on the circuit. Read the circuit pressure from the pressure gauge on the front on the ventilator.	50 ± 5 cm H ₂ O	Pass / Fail
Gradually turn off the driving gas supply. Ensure that the low gas supply alarm activates prior to the cessation of ventilation.	Alarm sounds	Pass / Fail

If the ventilator has passed all the above steps it is ready to return to clinical use. If the ventilator fails to pass any of the following tests do not apply it to patients. Call your local distributor or Airon Corporation Customer Support at 888-448-1238 (toll free USA & Canada) or +1-321-821-9433.. **Do not attempt to service the unit.**



CAUTION: Do not disassemble the **pNeuton** Ventilator. No internal user replaceable parts. All service must be performed by Airon Corporation or an approved service technician. Opening the device will negate the warranty. User will be responsible for all repair costs to service the unit.

Patient Ventilation

The ventilator operates with modes:

- CMV - Continuous Mechanical Ventilation
- IMV - Intermittent Mandatory Ventilation
- CPAP - Continuous Positive Airway Pressure

Using the Intermittent Mandatory Ventilation (IMV) mode, the ventilator provides an adjustable number of breaths per minute. The tidal volume of these breaths is also adjustable. The patient may breathe spontaneously between ventilator breaths as desired.

1. Set the % Oxygen control to the desired F_{iO_2} .
2. Set the Mandatory Breath control to On.
3. Set the Tidal Volume control to the appropriate level.
4. Adjust the Respiratory Rate control to achieve the desired mandatory breath frequency.
5. Adjust the Peak Pressure control to the desired level by turning the control while occluding the patient circuit and observing the level of pressure generated during a mandatory breath.
6. Attach the patient circuit to the patient and observe for appropriate ventilation. Adjust as required. External measurement devices should be used to verify ventilation parameters.
7. Adjust the PEEP / CPAP control to the desired level. There is no adjustment for spontaneous breath trigger sensitivity as this is automatically set by the ventilator.
8. Observe and monitor the patient and the ventilator per your institution's standards. If using a portable gas supply, monitor the supply level to insure there is sufficient gas for ventilation. If the patient is left without direct observation, an external disconnect monitor must be utilized.

Interrelationship of Volume and Rate Controls

There is an interrelationship between the Tidal Volume control and the Respiratory Rate control which must be considered while operating this ventilator. The Tidal Volume control is a calibrated control and will not vary from its setting during normal operation. It will not change if the Respiratory Rate control is changed. The Respiratory Rate control is calibrated for a set tidal volume between 500 ml and 900 ml. Lower tidal volumes will have higher rates, and higher tidal volumes will have lower rates. Once set, the tidal volume control will also not vary the patient's mandatory breath rate unless changed. However, if the Tidal Volume control setting is changed the actual respiratory rate may change even if the Respiratory Rate control is not moved.

The reason the rate will change when the tidal volume is changed is due to the operational characteristics of the ventilator. See Section 7 for a detailed description of the ventilator's Theory of Operation.

The Respiratory Rate control is calibrated for tidal volumes between 500 to 900 ml. This allows the rate control to be preset with initial set-up of the ventilator on a patient. Always count the patient's mandatory breath rate when first setting up the ventilator and after any changes to the tidal volume to assure the patient is receiving the proper respiratory rate.

The mandatory breath inspiratory flow is fixed at 36 L/min. Due to this flow rate limitation, it is possible that desired combinations of high tidal volume and respiratory rates may not be available. In other words, combinations of high tidal volumes and high mandatory breath rates are limited by the fixed mandatory breath flow rate. If a high respiratory rate is required, a lower tidal volume may be necessary. Likewise, if a high tidal volume is required, a lower respiratory rate may be needed.

Oxygen Control

The ventilator uses internal venturi systems which provide the oxygen concentration delivered to the patient. See Section 7 for a complete description of these systems. It is recommended that an external oxygen analyzer always be used to verify oxygen delivery.

Hypobaric Operation

The ventilator will operate normally at altitudes up to 15,000 feet. Changes in altitude will not affect pressure settings. However, delivered tidal volume increases and respiratory rate decreases with increasing altitude. This is due to lower barometric pressure than ventilator calibration at standard sea level.

To compensate for the effect of changing altitude on tidal volume and respiratory rate, use an external spirometer to verify tidal volume accuracy. Adjust the Tidal Volume and Respiratory Rate controls to the desired value as measured by the spirometer rather than the markings on the control panel.

Section 5: Patient Circuit

Adult / Pediatric Circuit



The patient circuit designed for use with the **pNeuton** Model S is part number 58001, 6 ft. disposable patient circuit. The compression volume is 1 ml per cm H₂O.

Additionally, a full range of compatible patient circuits are available to meet your needs. Other patient circuits may become available in the future. All acceptable circuits will have part numbers from 58001 to 58999.

Part Number	Description
58001	6 ft. (1.8 m) disposable, box of 15
58006	6 ft. (1.8 m) disposable, with expiratory filter, box of 15
58011	6 ft. (1.8 m) disposable, with large adult mask and head strap, box of 10
58021	6 ft. (1.8 m) disposable, with expiratory filter, large adult mask and head strap, box of 10
58051	8 ft. (2.4 m) disposable, box of 15

! WARNING: Patient circuits other than the Airon circuits listed above may alter the ventilator's CPAP / PEEP characteristics and / or expiratory flow resistance. They should **NOT** be used and may lead to patient harm.

! WARNING: Do not use air filters on the **expiratory port** of the patient circuit except those provided by Airon Corporation. Some filters may alter the ventilator's CPAP / PEEP characteristics and / or expiratory flow resistance. They should **NOT** be used and may lead to patient harm.

! CAUTION: The **pNeuton** ventilator requires the use of a non-vented full-face mask for proper device operation.

Ventilator Connection

The patient circuit must be attached to the ventilator properly. Incorrect attachment could result in failure to provide adequate ventilation.



The main breathing hose (22mm) is connected to the "Patient Connection" port.

The small tubing (3mm) connects the expiratory valve to the "Expiratory Valve" port.

NOTE: The Airon patient circuit is a single use, disposable device. Cleaning, reprocessing and / or reuse of this device is not recommended. The circuit and all components are sold clean and non-sterile.

Single-Use only Medical Devices/Accessories

How do I know if a device is Single-Use?



This symbol will be identified on the packaging and User's Manual of the device.

What does Single-Use mean?

Do not reuse. A single-use device is used on an individual patient during a procedure, such as transport ventilation, and then discarded. It is not intended to be reprocessed and used again, even on the same patient.

What is the concern with reused device labeled Single-Use?

The use of reprocessed devices may present serious incidents relating to the health and safety of patients and healthcare professionals. Reuse can be unsafe because of risk of:





- Cross-infection – inability to clean and decontaminate due to design, device components are not manufactured for disassembly and reassembly
- Endotoxin reaction – excessive bacterial breakdown products, which cannot be adequately removed by cleaning
- Patient injury – device failure from reprocessing or reuse because of fatigue or material alteration
- Chemical burns or sensitization – residues from chemical decontamination agents on materials that can absorb chemicals



NOTE: If you reuse a single-use device you may be legally liable for the safe performance of the device.

Section 6: Accessories

Using the **pNeuton** Ventilator should be convenient and user-friendly for healthcare providers and patients. Accessories for the device add serviceability in clinical situations and allow the device to adapt to the environment of use.

	<p>Adult/pediatric patient circuit</p> <ul style="list-style-type: none"> - Disposable, single patient use. - 6 foot (1.8m) and 8 foot (2.4m) length
	<p>Bacterial/Viral Filter</p> <p>Disposable, single patient use. Approved for use in-line and on expiratory valve.</p>
	<p>Test Lung</p> <p>A rigid wall Test Lung is ideal to test device performance and create spontaneous breaths.</p>
	<p>Adult/pediatric CPAP Masks—</p> <p>Disposable, single patient use.</p> <p>Adult Small Adult Medium Adult Large</p>
	<p>Bed Rail Mount</p> <p>MRI compatible Bed Rail Mount</p> <ul style="list-style-type: none"> - Allows the pNeuton ventilator to hang from standard critical care bed rails and stretchers. - Mount fits securely onto the top of the ventilator and provides a sturdy support during patient transport.

	<p>Travel Bag</p> <p>Holds the ventilator securely and safely for transport.</p> <ul style="list-style-type: none"> - pNeuton can be operated while in the bag. - Clear front panel, held closed with Velcro, can be opened to make control adjustments. - Bag has room for a patient circuit, a side pouch for masks or other items, a bright yellow reflective stripe, hand carry strap and a shoulder strap.
	<p>Oxygen Regulator</p> <p>MRI compatible high pressure oxygen regulator for D / E size oxygen tanks.</p>
	<p>Oxygen Cylinder</p> <p>E Size MRI compatible — A 600 liter green oxygen cylinder with yoke stem valve.</p>
	<p>High Pressure Oxygen Hose</p> <p>DISS Female both ends MRI compatible.</p> <p>3 foot, green flexible hose 8 foot, green flexible hose 12 foot, green flexible hose 30 foot, green flexible hose (Note: ISO color hose available)</p>

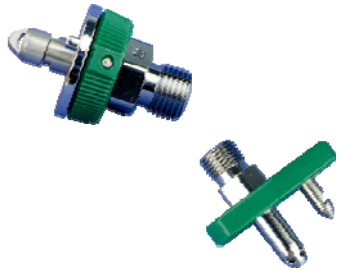

Specialty Quick Connects

- Attached to standard high pressure oxygen hoses.
- Fittings allow a quick attachment to a matching oxygen outlet without having to screw / unscrew a standard DISS connection.

Ohmeda Quick Connect
Chemtron Quick Connect



Reusable Patient Circuit

- Adult/pediatric patient circuit, autoclavable
- 1.8 meters (6 ft)

Available for International Customers Only.

Section 7: Theory of Operation

pNeuton is a pneumatic ventilator based upon the Intermittent Mandatory Ventilation (IMV) principle. As such, adjustable respiratory rate and tidal volume breaths are delivered to the patient between which the patient may breathe spontaneously. This section describes how the ventilator operates.

Further information on the ventilator's theory of operation, including circuit diagrams, parts lists, and calibration instructions are available from Airon Corporation to properly trained service personnel.

Pneumatic System Diagram

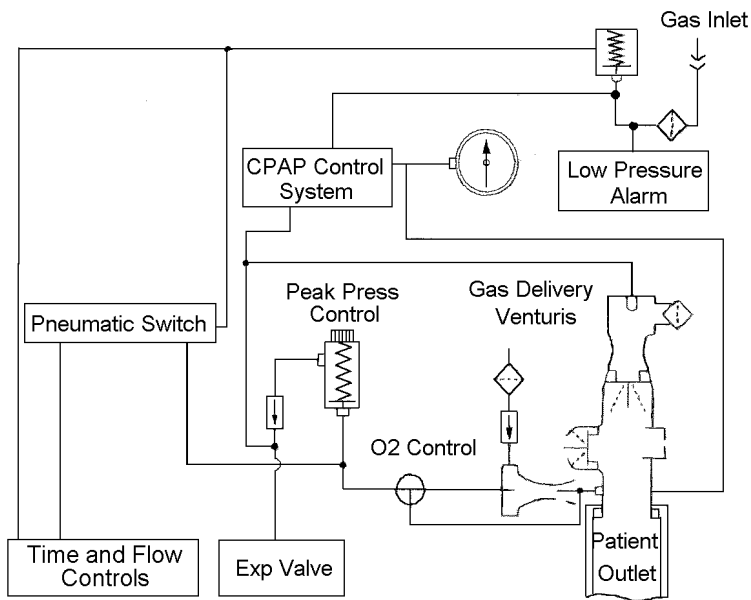

Pneumatic System Description

The major components of the pneumatic system and the control of gas flow through the ventilator are as follows:

1. High pressure gas (oxygen) enters the ventilator and is filtered (5 micron) and reduced to a lower working pressure (35 psi - 240 kPa).
2. The timing circuit uses two precision control valves to control inspiratory and expiratory time. These valves charge (or reduce) pressure to a pneumatic timing cartridge. This timing cartridge turns on or off the ventilator's main flow valve.
3. The main flow valve controls gas flow from the internal regulator to the % Oxygen control, which in turn delivers it to the patient. The % Oxygen control setting determines whether flow goes directly to the patient or through the high flow venturi. If gas is directed to the patient, a restrictive orifice limits the flow to a specific flow rate (36 L/min). If gas is directed to the high flow venturi, ambient air is entrained to provide precisely the same flow to the patient, but at a reduced $F_{I}O_2$ (approximately 65%). The high flow venturi provides stable performance (no stall) up to the maximum operating pressure (75 cm H_2O) of the ventilator.
4. The pressure generated by the main flow valve also powers the Peak Pressure control system. This system sends an adjustable pressure to the patient circuit expiratory valve. The pressure in this system determines the peak pressure that can be generated in the patient circuit.
5. The adjustable PEEP / CPAP system directs a pressure signal to the expiratory valve to generate PEEP and provides flow on demand for spontaneous breaths.

Tidal Volume and Rate Control System

pNeuton's Tidal Volume and Respiratory Rate controls actually function to determine mandatory breath inspiratory and expiratory time.

Since the ventilator provides a fixed flow (at 36 L/min or 600 ml/sec) during a mandatory breath, setting a specific inspiratory time also sets a specific tidal volume. This tidal volume is so precise that the inspiratory time control is calibrated to reflect the range of tidal volumes available (360 to 1,500 ml).

The ventilator's tidal volume output will not change in the face of increasing patient circuit pressure. The only change that will occur to actual patient delivered tidal volume will be caused by compression of gas based upon the compliance of the patient circuit used. The compression volume of the ventilator itself is negligible. With the Airon Corporation disposable patient circuit (part number 58001), the following tidal volume / patient circuit pressure relationships can be expected:

<u>Patient Pressure</u>	<u>Tidal Volume</u>		
	360 ml	800 ml	1200 ml
5 cm H ₂ O	360	800	1,200
15 cm H ₂ O	350	785	1,180
30 cm H ₂ O	340	775	1,165
60 cm H ₂ O	320	750	1,145

The Respiratory Rate control adjusts expiratory time. Rate is controlled by increasing or decreasing expiratory time. A longer expiratory time will equate to a slower respiratory rate. The range is 0.6 to 30 seconds. Tidal volume is not affected by changes to the Respiratory Rate control.

The Respiratory Rate control is calibrated for set tidal volumes between 500 and 900 ml. The calibrated Respiratory Rate range optimizes the interdependence between the expiratory and inspiratory time for ease of operation. If the tidal volume is changed and the rate is not changes, the number of breaths that can occur in one minute changes. For example:

Volume = 600, Respiratory Rate = 12
 (I time = 1 sec, E time = 4 sec, total time = 5 sec)
 Change the volume to 900
 (I time to 1½ sec)
 Resultant Respiratory Rate is now 11
 (total time for inspiration and expiration = 5½ sec)

Volume = 600, Respiratory Rate = 24
 (I time = 1 sec, E time = 1½ sec, total time = 2½ sec)
 Change the volume to 360
 (I time to 0.6 sec)
 Resultant Respiratory Rate is now 30
 (total time for inspiration and expiration = 2.1 sec)

Tidal volumes below 500 ml will result in **faster** rates than marked on the Respiratory Rate control. Tidal volumes higher than 900 ml will result in **slower** rates than marked on the Respiratory Rate control. The marks on the Rate Control are wide to reflect the range of control position that will provide the desired rate over the range of tidal volume. Always count the respiratory rate when first placing the ventilator on a patient and whenever changing tidal volumes.

As when using any mechanical ventilators, careful attention to detail is required. It is suggested that independent validation of tidal volume and rate be performed using external spirometers and timing devices.

Mandatory Breath Pressure Control System

During normal mandatory breath inspiration the expiratory valve functions to prevent gas from escaping through the expiratory valve. The pressure used to close the expiratory valve is set with the Peak Pressure control. The range is 10 to 75 cm H₂O.

The Peak Pressure adjustment can be used to manipulate the highest pressure applied during mandatory breaths.

- If volume limited ventilation is the goal, set the Tidal Volume control to the desired volume and the Peak Pressure control to at least 10 cm H₂O above the pressure required to deliver that tidal volume.

- If pressure limited ventilation is the goal, set the Tidal Volume control to the desired inspiratory time and the Peak Pressure control to the desired peak pressure. During pressure limited ventilation any excess flow will be released by the expiratory valve while maintaining the desired peak pressure. This flow release may cause a "honking" sound as gas escapes through the partially closed valve.

The Peak Pressure control can be tested by occluding the patient port of the patient circuit during a mandatory breath. During the breath the pressure will rapidly rise to the set peak pressure. Turn the Peak Pressure control until the desired peak pressure is achieved.

CPAP Demand Flow Breathing System

The ventilator's internal CPAP demand flow system provides gas for spontaneous breathing at adjustable CPAP pressures up to 20 cm H₂O. This system has several key features:

1. When turned on, the system supplies a continuous flow of gas at approximately 10 L/min during the

expiratory time of the ventilator. This flow of gas helps to establish the desired CPAP level by balancing flow with the pressure generated on the expiratory valve by the CPAP system.

2. The continuous flow of gas also establishes the flow sensitivity to spontaneous breathing efforts. If the patient's inspiratory flow demand exceeds the continuous flow of gas, additional flow will be added to meet patient demand. There is no sensitivity adjustment to this system. The CPAP system will automatically meet the needs of the patient, greater than 100 L/min, by attempting to maintain the balance between flow and pressure at the expiratory valve.
3. The PEEP / CPAP control is calibrated to the dynamics of Airon Corporation disposable patient circuit (part number 58001). Using this circuit will insure proper operation and the full 0 to 20 cm H₂O PEEP / CPAP range.

Oxygen Delivery System

With the ventilator driven by 100% oxygen as the source gas, the ventilator can be set to deliver 65% or 100% oxygen. There are two independent systems within the ventilator that determine oxygen concentration. The following section describes how these systems operate.

Mandatory Breaths

The % Oxygen control determines the oxygen concentration of the mandatory breaths that enter the patient circuit at the Patient Connection. When set for 65%, an internal high flow venturi system entrains ambient air to decrease the F_iO₂ while maintaining the correct tidal volume. The high flow venturi provides stable performance up to the maximum operating pressure (75 cm H₂O) of the ventilator.

Spontaneous Breaths

Spontaneous breaths are available from the internal CPAP system which uses a venturi mechanism separate from the mandatory breath high flow venturi. When turned on by the PEEP / CPAP control, the system delivers approximately 10 L/min baseline flow during the expiratory time of the ventilator.

The $F_{I}O_2$ of this system is set by the % Oxygen control. When set for 65%, the actual oxygen percentage and baseline flow is related to the level of CPAP in use. Up to 10 cm H_2O CPAP will provide a $F_{I}O_2$ of approximately 0.65. As the CPAP level raises to 20 cm H_2O , the $F_{I}O_2$ can be expected to increase to as high as 0.75 ± 0.10 . This is due to a drop off in efficiency (stalling) of the CPAP venturi system at higher CPAP levels. The actual $F_{I}O_2$ of spontaneous breaths will be approximately the same as the baseline flow. Whether set for 65% or 100%, extremely high inspiratory flow demand may decrease the desired $F_{I}O_2$.

It is recommended that an external oxygen monitor be used at all times to measure and display the delivered oxygen concentration.

 **WARNING:** Never operate the ventilator without proper oxygen gas supply at the required pressure.

Factors Effecting the Operating Time of Oxygen Tanks

There are several factors that effect the length of time the ventilator will operate from a tank of oxygen. The ventilator uses very little gas for it's own operation (less than 3 L/min) and is not a major factor in oxygen tank consumption. The major factors are:

- Volume of oxygen in the tank
- Patient's tidal volume and rate
- Position of the % Oxygen control
- If the PEEP / CPAP system is on or off

Setting the % Oxygen control to 65% will decrease the amount of oxygen used from the tank, nearly doubling the time an oxygen tank lasts.

NOTE: Always use full oxygen and air tanks before the start of any transport. The calculation of any expected run time becomes unreliable as tank pressure is reduced.

Example of expected operating time using a full "E" size cylinder (660 liters) PEEP/CPAP off

<u>Minute Volume</u>	<u>100% Oxygen</u>	<u>65% Oxygen</u>
5 l/m	77 min	120 min
10 l/m	40 min	76 min
15 l/m	33 min	60 min

The PEEP / CPAP system, when turned on, uses approximately 5 L/min oxygen from the tank to provide the 10 L/min baseline flow of the system. In addition, if the % Oxygen control is set for 100%, 5 more L/min is used. The patient's own spontaneous tidal volume and rate will use additional oxygen from the tank, based upon the tidal volume of those breaths.

Example of expected operating time using a full "E" size cylinder (660 liters) PEEP/CPAP on

<u>Minute Volume</u>	<u>100% Oxygen</u>	<u>65% Oxygen</u>
5 l/m	33 min	40 min
10 l/m	30 min	36 min
15 l/m	27 min	33 min

MRI Compatibility

The ventilator was engineered and built to be MRI compatible. Testing in a MRI scanner has shown that the scanner does not affect the ventilator's performance. The ventilator does not generate artifact, RF noise, or other deleterious effects on the operation of the MRI scanner or it's production of an image. In addition, due to **pNeuton** Ventilator components, heating of the ventilator does not occur during scanning.

Testing for MRI compatibility was done following ASTM MRI safety standards F2052 – 06e1 and F2119 – 07. The MRI scanner used has the following maximum performance levels:

- Static field strength - 3 Tesla
- Spatial field gradient - 720 G/cm

The scanner used for testing was an active shielded system. The ventilator was placed in the position of maximum field strength and maximum spatial gradient. The standard patient circuit (Airon part number 58031) was used. A standard imaging sequence with a maximum scanning time of 5 minutes was used.



The **pNeuton** Ventilator meets testing requirements for use within the Magnetic Resonance Environment with a conditional marking for safety.

NOTE: Airon recommends that users perform the above referenced tests in their MRI scanner prior to patient use.



WARNING: While tests show that the ventilator functions at the bore of the MRI unit, Airon Corporation does not recommend that the ventilator be clinically used at or within the bore of MRI scanners. A minimum proximity of 12 inches (0.3 meter) from the bore should be

used. In addition, safe MRI practice calls for all devices used in the proximity of a MRI scanner be anchored to prevent inadvertent movement.

Low Gas Supply Alarm

The Low Gas Supply Alarm will occur if the driving gas supply drops below safe levels (30 psi, 200 kPa). The alarm activates as long as driving gas is available or until the supply pressure returns to normal.

When operating from an oxygen cylinder the ventilator will gradually use up the gas in the cylinder and tank pressure will fall. Once the cylinder pressure reaches approximately 500 psi, most portable tank regulators will start to decrease pressure to the ventilator during mandatory breaths. As this happens that Low Gas Supply Alarm will sense the decreased pressure and begin to intermittently alarm each time the pressure drops. As pressure in the cylinder falls to lower values, the amount of time the regulator is delivering low pressure increases and the alarm sounds longer. Eventually the regulator is unable to maintain pressure and the alarm will sound continuously until all gas in the cylinder is used.

NOTE: The Low Gas Supply Alarm will only activate for a very short period of time if the gas supply abruptly ceases. This can occur if operating from a wall source and the gas supply hose is disconnected from the gas supply outlet. In fact, the Low Gas Supply Alarm may not sound at all when the ventilator is disconnected from a wall source. This is because all gas in the high pressure hose immediately exits out from where the hose was connected to the outlet and there is no gas pressure to power the ventilator's alarm. When using the ventilator on a patient always insure that the supply gas is secure and operating at the proper pressure.

Section 8: Troubleshooting

This troubleshooting guide lists common problems that may be encountered and possible solutions. If none of the corrective actions seem to work, contact Airon Corporation or your distributor.

Indication	Meaning	Corrective Action
Ventilator does not operate – no patient ventilation	Missing or insufficient driving gas supply	Check gas source, 55 psi (380 kPa) at 40 L/min is required
	Patient circuit disconnection	Reconnect patient circuit
	Internal Malfunction	Send ventilator for service
Ventilator seems to “want” to operate, but no breaths are generated	Peak Pressure control set too low	Increase Peak Pressure control
	Respiratory Rate set too low	Increase Respiratory Rate
	Expiratory Valve drive line disconnected	Ensure tubing is properly connected
	Expiratory Valve is malfunctioning	Replace patient circuit
	Insufficient driving gas supply	Check gas source, 55 psi (380 kPa) at 40 L/min is required
	Internal Malfunction	Send ventilator for service
	Ventilator appears to be stuck in inspiration	CPAP may be turned on high
Internal Malfunction		Send ventilator for service
Ventilator stops and starts	Insufficient driving gas supply	Check gas source, 55 psi (380 kPa) at 40 L/min is required

Indication	Meaning	Corrective Action
Lower minute volume than desired	Insufficient driving gas supply	Check gas source, 55 psi (380 kPa) at 40 L/min is required
	Leak in the Patient Circuit or Expiratory Valve	Replace patient circuit
	Obstruction of gas output	Check or replace patient circuit
	Use in hyperbaric condition	Ventilator should not be used in hyperbaric conditions
	Tidal volume control out of calibration	Send ventilator for service
	Internal malfunction	Send ventilator for service
Higher minute volume than desired	Use at higher altitude then calibration	Use external spirometer to verify tidal volume
	Tidal volume control out of calibration	Send ventilator for service
	Internal malfunction	Send ventilator for service
Tidal volume inaccurate	Leak in the patient ET-Tube, mask, breathing circuit or expiratory valve	Check patient interface. Replace patient circuit if at fault
	Ventilator is operating at an altitude different than calibration	Tidal volume should be measured by an external spirometer
	Tidal volume control out of calibration	Send ventilator for service

Indication	Meaning	Corrective Action
Rate Control inaccurate	Tidal volume set below 500 ml or above 900 ml	This is normal. Rate will be faster when tidal volume is set lower than 500 ml. Rate will be slower when tidal volume is set higher than 900 ml.
	Rate control out of calibration	Send ventilator for service
Patient pressure too high	Tidal Volume set too high	Decrease Tidal Volume or Peak Pressure setting
	Expiratory Valve malfunctioning	Replace patient circuit
	Internal malfunction	Send ventilator for service
	Patient response	ET-Tube may be occluded or patient may be biting tube
Can't get the PEEP / CPAP desired	Expiratory Valve malfunctioning	Replace patient circuit
	Using a circuit not recommended by Airon	Replace patient circuit
	Internal malfunction	Send ventilator for service
	Excessive "chattering" of CPAP system	Occurs when using some test lungs but will not when connected to a patient. If problem persists, send ventilator for service
Ventilator using too much gas	PEEP / CPAP system turned "on"	Turn off PEEP / CPAP system
	Leak at gas source	Check hoses and tank regulator for leaks
	Internal leaks	Send ventilator for service

Indication	Meaning	Corrective Action
Oxygen concentration too low	Source gas not 100% oxygen	Ensure source gas is 100% oxygen
	High patient spontaneous ventilation	Decrease spontaneous ventilation
	Internal malfunction	Send ventilator for service
Alarm Activated	Insufficient driving gas supply	Tank may be low. Check gas source, 55 psi (380 kPa) at 40 L/min is required
	Internal malfunction	Send ventilator for service
Alarm does not activate	Internal malfunction	Send ventilator for service
Visual alarm activates but audible does not	Reed Cap Malfunction	Replace reed cap on back of unit

Section 9: Cleaning and Maintenance

Cleaning the Ventilator

- Use only mild detergent or disinfectant and water with a soft cloth.
- Do not immerse the ventilator in water.
- Do not attempt to sterilize the ventilator with autoclave or ethylene oxide. Severe damage to the ventilator may occur.

Cleaning / Disinfecting the Patient Circuit

The Airon patient circuit is a disposable, single use device. This circuit must not be cleaned, disinfected or reused. See Single-Use only Medical Device information, page 5-3.

Routine Maintenance

Airon Corporation recommends that an Operational Verification Test (see Section 4) be performed at initial installation and prior to use on each patient. Institution's standards may require additional biomedical surveillance. No additional routine maintenance is required.



Factory Preventative Maintenance

- Ventilator service is required every 2 years to ensure continuous safety and reliability of the ventilator.
- Ventilator service includes:
 - Replacement of internal filters
 - Replacement of internal materials subject to wear
 - Reconditioning of the enclosure
 - Complete calibration

- This service must only be performed by Airon Corporation or its approved service technicians.
- Failure to perform this service may result in malfunctioning of the ventilator.

Section 10: Specifications

General Description

- Pneumatically operated ventilator provides automatic mechanical ventilation with a built-in PEEP / CPAP demand flow system for spontaneous breathing
- Patient ranges: pediatric to adult, ≥ 23 kg.
- Equipment not suitable for use in the presence of flammable anesthetics
- Rated for continuous operation

Ventilator System Performance

- Controls
 - Mandatory Breaths On or Off
 - Respiratory Rate from 2 to 50 bpm
 - Tidal Volume from 360 to 1,500 ml
 - Peak Pressure from 10 to 75 cm H₂O
 - PEEP / CPAP from 0 to 20 cm H₂O
 - % Oxygen 100% or 65%
- Operating Ranges
 - Inspiratory Time 0.6 to 2.5 seconds
 - Expiratory Time 0.6 to 30.0 seconds
 - Minute Volume 0.2 to 30 L/min
 - Flow Pattern square, 36 L/min
 - Internal P Limit 80 cm H₂O
- Accuracy of Controls
 - Respiratory Rate $\pm 10\%$ (V_T between 500-900)
 - Tidal Volume $\pm 10\%$
 - Peak Pressure $\pm 10\%$
 - PEEP / CPAP $\pm 5\%$
 - F₁O₂, mandatory breaths $\pm 10\%$

- Precision - breath to breath repeatability of controls
 - Respiratory Rate $\pm 10\%$
 - Tidal Volume ± 25 ml
 - Peak Pressure ± 5 cm H₂O
 - PEEP / CPAP ± 2 cm H₂O
 - F₁O₂ $\pm 5\%$
- Specificity - effect of one control on another
 - Respiratory Rate - if tidal volume is constant, $\pm 5\%$
 - Tidal Volume $\pm 5\%$
 - Peak Pressure $\pm 5\%$
 - PEEP / CPAP $\pm 5\%$
 - F₁O₂ $\pm 5\%$
- Internal Compliance 0.1 ml/cm H₂O
- Ventilator Resistance to Flow
 - Inspiratory, 60 L/min: less than 2 cm H₂O/l/sec
 - Expiratory, 50 L/min: less than 2 cm H₂O/l/sec

Alarm System

- Low Gas Supply
 - Input supply pressure: less than 30 psi (2.1 bar)
 - Cannot be silenced

Environmental and Physical Characteristics

- MRI Conditional. Tested with a scanner up to:
 - Maximum static field strength - 3 T
 - Maximum spatial field gradient - 720 G/cm
- Hypobaric (high altitude) compatible up to 15,000 feet (5,000 meters)
- Weight and Size: 6 pounds (2.7 kg), approximately 4.0"H x 9.0"W x 6.5"D (10.2 cm x 22.9 cm x 16.5 cm)

- Storage Temperature Range: -46 to 71 °C (-51 to 160 °F), 15 to 95 percent humidity, noncondensing
- Operating Temperature Range: -26 to 60 °C (-15 to 140 °F), 15 to 95 percent humidity, noncondensing

Power Sources

- Driving gas requirement
 - 55 psi \pm 15 psi (380 kPa \pm 100 kPa)
 - 100% oxygen. Do not use the ventilator with other types of gases.
 - The gas supply must be capable of delivering at least 40 liters per minute at 55 psi. If input pressure drops less than 40 psi due to insufficient gas flow, the ventilator will alarm and begin to malfunction.

NOTE: Driving gas consumption at 10 L/min minute volume;

- PEEP / CPAP off: 3 L/min
- PEEP / CPAP on, 65% Oxygen: 8 L/min
- PEEP / CPAP on, 100% Oxygen: 13 L/min

Section 11: Limited Warranty

AIRON CORPORATION, through its Official Distributor, warrants this product to be free from defects in construction, material and workmanship for a period of twelve (12) months from the date of original delivery to buyer when operated properly under conditions of normal use for which the product is intended. This twelve (12) month warranty does not extend to expendable items such as membranes, hoses, patient circuits and filters which are warranted to be free of defects only at time of original delivery.

The official AIRON CORPORATION Distributor will, at its option, either repair or replace any defective product, as above defined, which is reported to that AIRON CORPORATION Distributor within 72 hours of occurrence during the warranty period. If so instructed by the Distributor, such defective products must be returned to the official AIRON CORPORATION Distributor in the original container with freight charges prepaid. In any case, AIRON CORPORATION shall be responsible for repairs to, or replacement of, such defective product only.

LIMITATIONS ON AND DISCLAIMER OF WARRANTIES:

AIRON CORPORATION shall be relieved of any liability under this warranty: if the product is not used in accordance with manufacturer's instructions; if attachment or incorporation of any device is made to this product without written approval; if use is made in any manner other than intended by the manufacturer; if regular periodic maintenance and service is not performed; if repairs are made by other than authorized AIRON CORPORATION service personnel; if the product has been subject to abuse, misuse, negligence or accident. Any product that has been mechanically or electronically altered without

specific written authorization from AIRON CORPORATION is also excluded from this warranty.

The warranty described in this Agreement is in lieu of all other warranties. THE PARTIES AGREE THAT THE IMPLIED WARRANTIES OF MERCHANTABILITY AND FITNESS FOR A PARTICULAR PURPOSE AND ALL OTHER WARRANTIES, EXPRESS OR IMPLIED, ARE EXCLUDED FROM THIS AGREEMENT.

Except as stated above, AIRON CORPORATION SHALL NOT BE LIABLE FOR ANY DAMAGES, CLAIMS OR LIABILITIES INCLUDING, BUT NOT LIMITED TO, PERSONAL BODILY INJURY, OR INCIDENTAL, CONSEQUENTIAL, OR SPECIAL DAMAGES.

Section 12: Index

- A**
 - Administering Oxygen 4-4
 - Airway Connection Port 3-2
 - Alarms
 - High Pressure 3-5
 - Low Gas Supply 3-5, 7-10, 10-2
 - Altitude Operation 4-5
 - Anti-Suffocation System 3-4
- C**
 - Cautions 2-3
 - Circuit, Patient Breathing
 - Cleaning 9-1
 - Configuration 5-1
 - Connecting 5-2
 - Cleaning
 - Patient Breathing Circuit 9-1
 - Ventilator 9-1
 - Contraindications 2-5
 - Controls
 - % Oxygen 3-2
 - Peak Pressure 3-1
 - PEEP / CPAP 3-1
 - Respiratory Rate 3-2
 - Tidal Volume 3-1
 - Continuous Flow - CPAP 7-5
 - CPAP
 - Control 3-1
 - Functional Operation 7-5
 - Trigger Sensitivity 7-6
- E**
 - Expiratory Valve
 - Connection 5-2
 - Relationship to PEEP / CPAP System 7-6
- F**
 - Front Panel 3-1
- H**
 - High Altitude Operation 4-5
 - High Pressure Alarm 3-5
 - Hyperbaric Operation 2-5
 - Hypobaric Operation 4-5
- I**
 - Indications For Use 2-5
 - Interrelationship Between Volume and Rate Controls 4-4
- L**
 - Low Gas Supply Alarm 3-5, 7-10
- M**
 - Maintenance - Ventilator Service 9-1
 - Mandatory Breaths
 - F_IO₂ 4-3
 - Flow Rate 7-3
 - Interrelationship Between Volume & Rate Controls 7-3
 - Medical Symbol Key 2-7
 - Mode of Operation 7-1
 - MRI Compatibility 7-9
- N**
 - Notes 2-4
- O**
 - Operational Verification 4-2
 - Oxygen
 - % Oxygen Control 3-2
 - Driving Gas Inlet 3-3
 - Driving Supply Requirements 10-3
 - Operational Characteristics 7-6
 - Tank, Expected Operating Time 7-8

P

Patient Circuit

- Cleaning 9-1
- Configuration 5-1
- Connecting 5-2
- Single Use 5-3

Patient Ventilation 4-3

Peak Pressure Control 3-1

Performance Verification 4-2

PEEP / CPAP

- Control 3-1
- Functional Operation 7-5
- Trigger Sensitivity 7-6

Pneumatic System 7-2

Pneumatic Low Gas Supply Alarm 3-3, 10-2

Power Requirements - Driving Gas Supply 10-3

Pressure

- Peak Pressure Control 3-1
- PEEP / CPAP Control 3-1

Pressure Gauge 3-1

Principles of Operation

- CPAP Demand Flow Breathing System 7-5
- Low Gas Supply Alarm 7-10
- Mandatory Breath Pressure Control System 7-5
- Oxygen Delivery System 7-6
- Pneumatic System Diagram 7-1
- Pneumatic System Description 7-2
- Tidal Volume and Rate Control System 7-3

R

Rear Panel 3-3

Respiratory Rate

- Control 3-2
- Interrelationship Between Volume & Rate Controls 4-4, 7-3

S

Safety Systems 3-5

Sensitivity 7-6

Set Up 4-1

Service, Ventilator 9-1

Single-Use only Devices/Accessories 5-3

Specifications

- Alarm System 10-2
- Environmental and Physical Characteristics 10-2
- General Description 10-1
- Power Sources 10-3
- Ventilator System Performance 10-1

Spontaneous Breaths

- F_IO₂ 7-7
- Peak Flow 7-5

T

Tidal Volume

- Control 3-1
- Interrelationship Between Volume & Rate Controls 4-4, 7-3

Theory of Operation

- CPAP Demand Flow Breathing System 7-5
- Low Gas Supply Alarm 7-10
- Mandatory Breath Pressure Control System 7-5
- Oxygen Delivery System 7-6
- Pneumatic System Diagram 7-1
- Pneumatic System Description 7-2
- Tidal Volume and Rate Control System 7-3

Troubleshooting Ventilator 8-1

U

Unique Device Identifier (UDI) 3-4

V

Ventilator Service 9-1

Verification, Operating 4-2

W

Warnings 2-1