

MACS[®] epic **Mask CPAP System**

Operators Manual

REF 97051

CD-ME-005 Rev A

Released 25 September 2015

The **MACS epic** CPAP delivery system is under US patent protection as part of the **pNeuton®** Ventilator (Patent # 6,591,835)

pNeuton and MACS are Registered Trademarks of the Airon Corporation

Copyright © 2015 by Airon Corporation



Manufactured by:



Airon® Corporation

751 North Drive

Unit 6

Melbourne, Florida 32934

USA

Tel: 888-448-1238 (toll free USA & Canada)

+1-321-821-9433

Fax: +1-321-821-9443

www.AironUSA.com



Intertek



Intertek



Emergo Europe

Molenstraat 15

2513 BH The Hague

The Netherlands

Table of Contents

Section 1. General Description	1-1
Indications for Use	1-1
Contraindications	1-2
Section 2. Warnings, Cautions, Notes	2-1
Warnings	2-1
Cautions	2-3
Notes	2-3
Medical Symbol Key	2-5
Section 3. Controls and Patient Safety Systems ..	3-1
Front Panel	3-1
Rear Panel	3-3
Unique Device Identifier	3-5
Internal Patient Safety Systems	3-6
Section 4. Operating Instructions	4-1
Device Set-up	4-1
Operational Verification	4-2
Patient Set-up.....	4-3
Oxygen Control	4-4
Disconnect Alarm	4-4
Hypobaric Operation	4-6
Section 5. Patient Circuit	5-1
Adult / Pediatric Circuit	5-1
Patient Connection	5-2
Single-Use Medical Devices/Accessories	5-3
Section 6. Accessories	6-1
Section 7. Theory of Operation	7-1
Pneumatic System Diagram	7-1
Pneumatic System Description	7-2
CPAP Demand Flow Breathing System	7-2
Oxygen Delivery System	7-3

Disconnect Alarm	7-6
Low Gas Supply Alarm	7-7
Section 8. Troubleshooting	8-1
Section 9. Cleaning and Maintenance	9-1
Cleaning the Device	9-1
Cleaning / Disinfecting the Patient Circuit	9-1
Routine Maintenance	9-1
Factory Preventative Maintenance.....	9-1
Section 10. Specifications	10-1
General Description	10-1
System Performance	10-1
Alarm System	10-2
Environmental and Physical Characteristics	10-2
Power Sources	10-2
Section 11. Limited Warranty	11-1
Section 12. Index	12-1

MACS epic Mask CPAP System

Section 1: General Description

MACS epic is a small, lightweight Continuous Positive Airway Pressure (CPAP) system designed for use on spontaneously breathing patients who require oxygen assistance. The patient is allowed to breath spontaneously with minimal work of breathing. The CPAP system provides expiratory positive pressure delivered non-invasively via face mask or invasively via ET tube. The delivered oxygen is adjustable from 21 to 100 percent, with oxygen and compressed air as the driving source gas. For the convenience of transport, the device can be operated from oxygen only source gas with delivered oxygen at 65 percent.

MACS epic is an all pneumatic device. Electrical power is not required for operation. **MACS epic** has been specifically designed for patient support by trained emergency medical professionals, respiratory therapists, nurses and physicians, both in the prehospital and hospital environment. It may also be used at the accident scene, during intra and inter-hospital transport, in aircraft, on ambulances, and in emergency rooms.

Indications for Use

The **MACS epic** CPAP System is intended for spontaneously breathing patients requiring respiratory positive pressure support with demand flow up to 140 L/min. Oxygen delivery can be managed with oxygen and compressed air (21 – 100%) or oxygen source gas alone (65%).

The device is suitable for use in:

- Hospital ICU transport applications including emergency,

- surgery and anesthesia
- Hospital critical care management for post-anesthesia / recovery and post-intubation
 - Hospital non-critical care applications for pulmonary management and continuous care
 - Pre-hospital transport applications including respiratory failure, accident scene and emergency rescue vehicles
 - Air transport via helicopter or fixed wing

Contraindications

The following conditions contraindicate the use of the **MACS epic** CPAP System:

- Patients undergoing procedures with flammable anesthetic gasses
- Patients requiring ventilatory support with mechanical respiratory rate and tidal volume

Section 2: Warnings, Cautions, Notes

The **MACS epic** CPAP System is intended for use by properly trained personnel under the direct supervision of a licensed medical Physician or Practitioner only. Personnel must become thoroughly familiar with this Operators Manual prior to using the **MACS epic** CPAP System on a patient.

As used in this manual, the following terms mean:

Warning: Indicates the possibility for injury to the patient or the operator

Caution: Indicates the possibility of damage to the device

Note: Places emphasis on an operating characteristic

Warnings

This manual serves as a reference. The instructions in this manual are not intended to supercede the physician's instructions regarding the use of the **MACS epic** CPAP System.

The operator should read and understand this entire manual before using the **MACS epic** CPAP System. Incorrect operation can be hazardous.





DO NOT use the **MACS epic** CPAP System in conjunction with flammable anesthetics or in the presence of open flame. Ensure the device and all accessories are free from oil or grease.

MACS epic uses air entrained from the atmosphere. Do not use in contaminated (hazardous, explosive) atmospheres. Only compressed oxygen and medical air may be used.

 **DO NOT** use conductive (anti-static) patient breathing circuits. The only approved patient circuit for use with **MACS epic** CPAP System are the Airon® circuits listed in Section 5 of this manual. Any other patient circuit should **NOT** be used and may lead to patient harm.

 The Airon patient circuit is a single use, disposable device. Cleaning, reprocessing and / or reuse of this device is not recommended. Reprocessing may cause a change in ventilation characteristics. The circuit and all components are sold clean and non-sterile.

 The Operational Verification tests as described in this manual (Section 4) must be performed prior to connecting a patient to the device. If the device fails any of the tests it must be removed from clinical use. **DO NOT** return the unit to clinical use until all repairs has been completed by an Airon approved repair facility and all operational verification tests are acceptable.

 The Low Gas Supply Alarm will occur if the difference between the two gas supply pressures is more than 15 psi (100 kPa). The alarm activates as long as driving gas is available or until supply pressure returns to normal. This alarm cannot be silenced. During the alarm the patient receives only the gas supply that is at the higher input pressure. The alarm will activate for a very short period of time if the gas supply abruptly ceases as can happen if the supply gas becomes disconnected. Always insure that the supply gas is secure and operating at the proper pressure. There is no Low Gas Supply Alarm if the **MACS epic** is set for Oxygen Only operation (for transport).

Cautions

Insure that **clean, dry** medical grade compressed air is used at all times. Compressed air that is contaminated with water or other material will damage the internal components of the device.



DO NOT attempt to service the unit. Service may only be performed by Airon® Corporation authorized engineers. The Preventative Maintenance program requires a general service and calibration every two years. Only original manufacturer parts and accessories should be used, and only factory-trained personnel may perform Preventative Maintenance.

Any attempts to modify the hardware of this device without the express written approval of Airon Corporation will void all warranties and liabilities.

Do not immerse the **MACS epic** CPAP System or allow any liquid to enter the case or the inlet filter. Clean as directed in Section 9, Cleaning and Maintenance.

Notes

In the USA, the **MACS epic** CPAP System is a restricted medical device intended for use by qualified medical personnel under the direction of a physician.













The CPAP system will operate normally at altitudes up to 15,000 feet. Changes in altitude will not affect CPAP pressure provided to the patient.

Special note on the presence of latex: The components, devices, accessories, and packaging that make up the **MACS epic** CPAP System do not contain any dry natural rubber or natural rubber latex, which may cause allergic reactions.

Special note on the presence of di (2-ethylhexyl) phthalate (DEHP): The components, devices, accessories, and packaging that make up the **MACS epic** CPAP System do not contain any phthalates which are classified as carcinogenic, mutagenic or toxic to reproduction, of category 1 or 2, in accordance with Annex I to Directive 67/548/EEC.

Additional Warnings, Cautions, and Notes are located throughout this manual.

Airon's Medical Symbol Key

	Consult Instructions of Use
	CE Marked
	Authorized Representative in European Community
	Model (Part) Number
	Lot Number
	Do Not Reuse
	Manufacturer
	Manufactured Date
	Use By Date
	Keep Dry
	Caution, serious injury or device damage may occur by disregarding the instructions accompanying this warning symbol.

Section 3: Controls and Patient Safety Systems

Front Panel

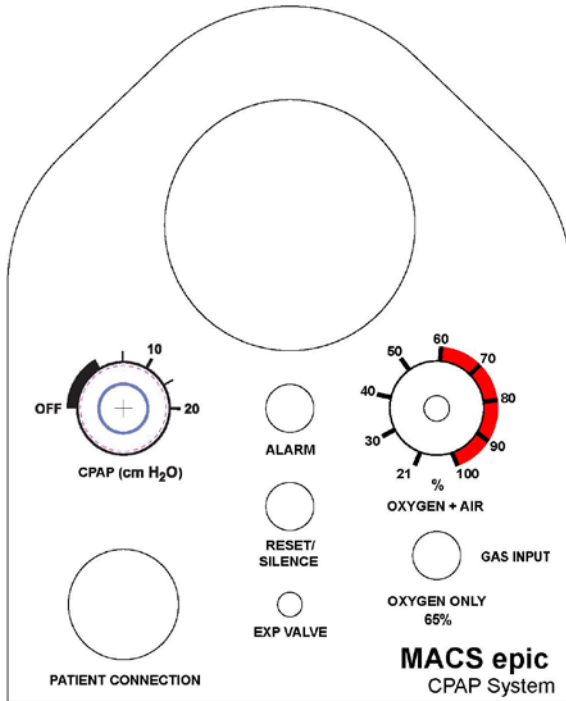

Pressure gauge, patient circuit pressure

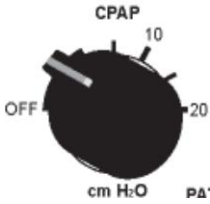

CPAP control, calibrated,
range 0 to 20 cm H₂O

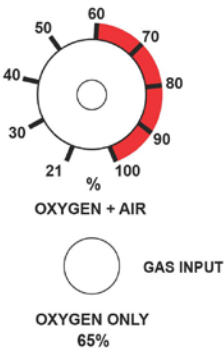

Oxygen control, (F_IO₂)
Gas Input selector

UP position:
Range 21% to 100%,
calibrated

DOWN position:
65% oxygen



ALARM

Alarm visual indicator



**RESET /
SILENCE**

Alarm Reset / Silence,
22 second alarm delay,
1 min silence



Patient Connection

Patient Circuit connection, see Section 5 for a complete description of the patient circuit and its attachment to the front panel



EXP Valve

Expiratory Valve connection

Rear Panel

<p>Warning Do not use in the presence of flammable anesthetics. Use only with the Airon approved patient circuit.</p>	<p>MACS[®] epic CPAP System</p>	<p>Alarm DO NOT OBSTRUCT</p>
<p>Caution Read and understand operating instructions prior to use. Do not disassemble. No user replaceable parts. Federal law (USA) restricts this device to sale or use on order of a physician.</p>	<p>Serial Number:</p> <p>Made in the USA by: Airon Corporation 751 North Drive, Unit 6 Melbourne, Florida USA</p>	
<p>Driving Gas Inputs 55 ± 15 psi 380 ± 100 kPa (40 L/min minimum)</p>		
<p>OXYGEN</p>	<p>MEDICAL AIR</p>	<p>REMOTE ALARM</p>
<p>CE 0413</p>		



Driving Gas Input
(Oxygen)
55 ± 15 psi
380 ± 100 kPa
(40 L/min minimum)



Driving Gas Input (oxygen), DISS connection, requires 55 ± 15 psi (380 ± 100 kPa), (40 liter/minute minimum)



Driving Gas Input
(Medical Air)
55 ± 15 psi
380 ± 100 kPa
(40 L/min minimum)



Driving Gas Input (compressed air), DISS connection, requires 55 ± 15 psi (380 ± 100 kPa), (40 liter/minute minimum)



Ambient Air Inlet filter

Unique Device Identification (UDI)

Pursuant to the U.S. FDA Unique Device Identification (UDI) Rule, each device must bear a UDI code. The UDI for MACS epic CPAP System is located under the “Serial Number:” labeling, in plain text, on the back panel of the device. The UDI code consists of one Device Identifier (DI) and potentially four Production Identifiers (PI). Therefore, UDI = DI+PI. Production identifiers are required if the information appears on the product (box) label. The UDI on the product (box) label appears in both plain text and machine-readable format. The numbers in the parentheses indicate different parts of the UDI, as applicable to the device:

- (01) Device Identifier
- (10) Batch / Lot Number
- (11) Manufacturing / Production Date
- (17) Expiration Date
- (21) Serial Number

The format for Manufacturing / Production date and Expiration date within the UDI code is: YYMMDD

- YY = tens and units of the year (e.g. 2014 = 14)
- MM = number of the month (e.g. January = 01)
- DD = number of the day (e.g. third day = 03)
- January 03, 2014 = 140103

An example UDI for the MACS epic CPAP system is as follows:

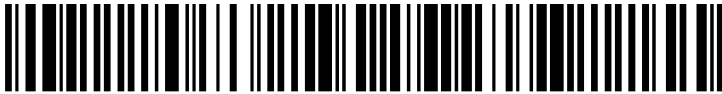

(01)00853678006047(21)ME0000

Device Identifier = 00853678006047
Serial Number = ME0000

The Device Identifier portion of the code may be entered into AccessGUDID to obtain information about the product.
<http://accessgudid.nlm.nih.gov/>

Internal Patient Safety Systems

The **MACS epic** CPAP System has the following internal safety systems. These systems help ensure patient safety in the event of device malfunction.

High Pressure Release

There is an internal safety pressure release valve included in the **MACS epic** CPAP System. This valve will automatically limit circuit pressure to approximately 42 cm H₂O, regardless of the setting of the CPAP control.

Anti-Suffocation System

An internal safety system will allow the patient to breathe on his or her own in the event of device malfunction. At approximately 2 cm H₂O negative pressure an internal valve will open allowing unimpeded ambient air to enter the patient circuit for the patient. This system is always available to the patient, irrespective of control settings.

Low Gas Supply Alarm

With Gas Input control set for Oxygen + Air, the Low Gas Supply Alarm is active and monitors the internal oxygen blender. This alarm will occur if either driving gas supply (Air or Oxygen) drops below safe levels for accurate gas mixing. The visual alarm indicator will illuminate and an internal pneumatic audible alarm will sound. The alarm will continue to sound until all pressure has been lost in the system.



WARNING: The Low Gas Supply Alarm will only activate for a very short period of time if the gas supply abruptly ceases as can happen if the supply gas becomes disconnected. Always insure that the supply gas is secure and operating at the proper pressure.



CAUTION: When using only oxygen as an input gas during transport (Gas Input control set for Oxygen only) there is no Low Gas Supply Alarm if the oxygen supply pressure is lost.

Disconnect Alarm

The device automatically monitors patient pressure at all times. If there is a disconnection in the patient circuit the visual alarm indicator will illuminate and the audible alarm will sound. The alarm activates when a patient circuit disconnect is sensed if the pressure in the patient circuit is less than 5 cm H₂O for 22 seconds.

The Disconnect Alarm may be silenced for 1 minute by pressing the alarm Reset / Silence button.

Note: Always use an external oxygen monitor to ensure the desired oxygen percentage is delivered to the patient.

Section 4: Operating Instructions

Device Set-up

The following equipment is needed:

1. **MACS epic** CPAP device with breathing circuit (See Section 5)
2. High pressure oxygen hose with pressure regulated oxygen supply
3. High pressure medical air hose with pressure regulated medical air supply
4. Test lung, (1 Liter rigid wall, Airon Part #21002)
5. Calibrated oxygen analyzer with 22 mm tee piece sensor

When ready:

1. Attach breathing circuit to device following instructions in the Operators Manual.
2. Attach the test lung to the patient side of the breathing circuit. Place the oxygen sensor between the test lung and the circuit.
3. With the device set up as described above, adjust the controls as follows:
 - a. Oxygen % to 60%
 - b. Gas Input selector to Oxygen + Air
 - c. CPAP to 10 cm H₂O.
4. Attach Oxygen and Air inputs on rear panel of the device using proper hoses to high pressure gas sources and turn on the supply pressure.

NOTE: The unit will begin operation at the above settings when the gas supplies are turned on.

Operational Verification

Verification Step	Acceptable Range	Result
Expand the test lung at a rate of approximately 10 breaths per minute to simulate spontaneous breathing. Ensure that the pressure gauge returns to 10 ± 2 cm H ₂ O after each breath.	10 ± 2 cm H ₂ O	Pass / Fail
Continue to simulate breaths and measure the oxygen concentration	$60 \pm 10\%$	Pass / Fail
Switch the Gas Input toggle to Oxygen Only. The alarm will sound. Turn off/disconnect the compressed air source and the alarm will stop.	Visual and audible alarm	Pass / Fail
Expand the test lung at a rate of approximately 10 breaths per minute and ensure the pressure gauge returns to 10 ± 2 cm H ₂ O after each breath.	10 ± 2 cm H ₂ O	Pass / Fail
Stop simulated breathing. Turn the CPAP knob to the off position. Ensure the pressure gauge points inside the off range and flow stops.	Off	Pass / Fail
After approximately 22 seconds the alarm should sound. When it does press the alarm silence and the alarm will stop.	Visual and audible alarm	Pass / Fail
Wait until the alarm starts again. It should be approximately 1 minute. Turn off/disconnect the oxygen pressure and the alarm will stop.	Visual and audible alarm	Pass / Fail

When the device has passed the Operational Verification procedure it is ready for clinical use. If the device fails to pass any of the following tests do not apply it to patients. Call your local distributor or Airon Corporation Customer Support at 888-448-1238 (international +1-321-821-9433). **Do not attempt to service the unit.**



CAUTION: Do not disassemble the **MACS epic** CPAP System. There are no internal user replaceable parts. All service must be performed by Airon Corporation or an approved service technician. Opening the device will negate the warranty. The user will be responsible for all repair costs to service the unit.

Patient Set-up

1. Set up the **MACS epic** CPAP System according to the set-up instructions above.
2. Attach the patient circuit with non-vented face mask to the device. If the patient is intubated, you may attach the circuit directly to the endo-tracheal tube.
3. Set the Gas Input control to match the gas supply used for patient care. If using both oxygen and medical air supplies, place the toggle in the up position. If using oxygen only, set the toggle to the down position.
4. If using the Oxygen + Air Gas Input, adjust the % Oxygen control to the desired F_{iO_2} .
5. Adjust the CPAP control to the desired level. There is no adjustment for spontaneous breath trigger as the device automatically sets the sensitivity.
6. Inform the patient of what you will be doing and apply the face mask (or connect to the ET-Tube).
7. Monitor the pressure gauge to ensure proper delivery of CPAP. Pressure should not vary more than 3 to 4 cm H_2O per breath, depending on patient effort.

8. Observe and monitor the patient and the device per your institution's standards. If using a portable oxygen gas supply, monitor the supply level to ensure there is sufficient gas to power the device.

Oxygen Control

The Gas Input control setting must match the gas pressure being used. If both oxygen and medical air are provided the control must be set for Oxygen + Air. In this setting the internal oxygen blender functions to deliver the F_iO_2 as set by the % Oxygen control. If only oxygen is provided the control must be set for Oxygen Only. The device then uses an internal venturi system, which provides 65% oxygen concentration. If the Gas Input selector is set incorrectly an alarm will sound that cannot be silenced. See Section 7 for a complete description of the Oxygen Delivery System. It is recommended that an external oxygen analyzer always be used to verify oxygen delivery.

Disconnect Alarm

The **MACS epic** has a patient circuit disconnect alarm system. This system cannot be turned off. If a circuit disconnect is sensed, the visual indicator on the front panel will illuminate and the audible alarm will sound.

The alarm will activate as soon as a gas source is supplied to the device. You may silence the alarm for 60 seconds by pressing the Reset / Silence button. Attaching the device to a patient with CPAP delivery will automatically reset the alarm system and turn off the audible and visual indicators.

A patient circuit disconnect is sensed if the pressure in the patient circuit is less than 5 cm H_2O for 22 seconds. If the CPAP pressure is at 5 cm H_2O or greater the alarm is deactivated, waiting for a low pressure condition to occur.

The alarm system can be momentarily silenced by pressing the Reset / Silence button on the front panel. Pressing this button turns off the visual and audible indicators for 60 seconds. Each time the Reset / Silence button is pressed; the alarm system restarts the 60 second silence time delay. This delay is NOT cumulative. In other words, repeatable pressing of the Reset / Silence button will not increase the silence time by more than 60 seconds.

The alarm system provides a remote alarm output on the rear panel of the **MACS epic**. Use the Airon Remote Alarm (Part Number 21031) to provide a remote audible and visual indication of active alarm conditions.

Hypobaric Operation

The device will operate normally at altitudes up to 15,000 feet. Changes in altitude will not affect pressure delivery to the patient. Always monitor the patient carefully using a cardiac monitor and pulse oximeter.

Section 5: Patient Circuit

Adult / Pediatric Circuit

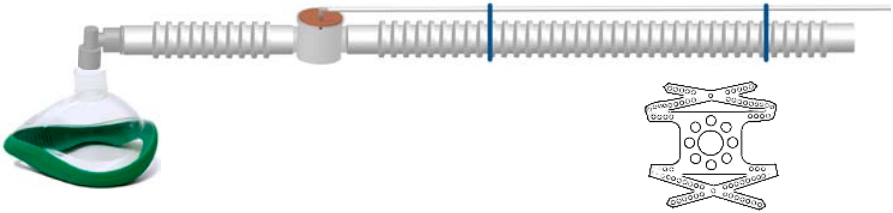

Large adult mask (short term)

Headstrap

The patient circuit designed for use with the **MACS epic** CPAP System is part number 58011; 6 ft. disposable patient circuit with disposable face mask (size Large) and headstrap. The compression volume is 1 ml per cm H₂O.

Additionally, a full range of compatible patient circuits is available to meet your needs. Other patient circuits may become available in the future. All acceptable circuits will have part numbers from 58001 to 58999.

Part Number	Description
58001	6 ft. (1.8 m) disposable, box of 15
58006	6 ft. (1.8 m) disposable, with expiratory filter, box of 15
58011	6 ft. (1.8 m) disposable, with large adult mask and head strap, box of 10
58021	6 ft. (1.8 m) disposable, with expiratory filter, large adult mask and head strap, box of 10
58051	8 ft. (2.4 m) disposable, box of 15



WARNING: Patient circuits other than the Airon[®] circuits listed above may alter the device's CPAP characteristics and / or expiratory flow resistance. They should **NOT** be used and may lead to patient harm.

 **WARNING:** Do not use air filters on the **expiratory port** of the patient circuit except those provided by Airon Corporation. Some filters may alter the device's CPAP characteristics and / or expiratory flow resistance. They should **NOT** be used and may lead to patient harm.

 **CAUTION:** The **MACS epic** requires the use of a non-vented full-face mask for proper CPAP operation when using a mask application.

Patient Connection

The patient circuit must be attached to **MACS epic** properly. Incorrect attachment could result in failure to provide adequate oxygen delivery.



The main breathing hose (22mm) is connected to the large connection port.



The small tubing (3mm) connects the expiratory valve to the small connection port.

NOTE: The Airon patient circuit is a single use, disposable device. Cleaning, reprocessing and / or reuse of this device is not recommended. The circuit and all components are sold clean and non-sterile.

Single-Use only Medical Devices/Accessories

How do I know if a device is Single-Use?



This symbol will be identified on the packaging and User's Manual of the device.

What does Single-Use mean?

Do not reuse. A single-use device is used on an individual patient during a procedure, such as transport ventilation, and then discarded. It is not intended to be reprocessed and used again, even on the same patient.

What is the concern with reused device labeled Single-Use?

The use of reprocessed devices may present serious incidents relating to the health and safety of patients and healthcare professionals. Reuse can be unsafe because of risk of:

- Cross-infection – inability to clean and decontaminate due to design, device components are not manufactured for disassembly and reassembly
- Endotoxin reaction – excessive bacterial breakdown products, which cannot be adequately removed by cleaning
- Patient injury – device failure from reprocessing or reuse because of fatigue or material alteration
- Chemical burns or sensitization – residues from chemical decontamination agents on materials that can absorb chemicals



NOTE: If you reuse a single-use device you may be legally liable for the safe performance of the device.

Section 6: Accessories

Using the **MACS epic** CPAP System is convenient and user-friendly for healthcare providers and patients. Accessories for the device add serviceability in clinical situations and allow the device to adapt to the environment of use.

	<p>Adult/pediatric patient circuit</p> <ul style="list-style-type: none">- Disposable, single patient use.- 6 foot (1.8m) and 8 foot (2.4m) length
	<p>Adult/pediatric CPAP Masks</p> <p>Disposable, single patient use.</p> <p>Adult Small Adult Medium Adult Large</p>
	<p>Bacterial/Viral Filter</p> <p>Disposable, single patient use. Approved for use in-line and on expiratory valve.</p>
	<p>Safe-T-Vent Nebulizer</p> <p>Designed to nebulize medications for inhalation in conjunction with the MACS epic CPAP System and other positive pressure breathing devices. This unique nebulizer system includes a spring-loaded seal that allows the nebulizer to be removed while maintaining positive pressure.</p>
	<p>Test Lung</p> <p>A rigid wall Test Lung is ideal to test device performance and create spontaneous breaths.</p>



Remote Alarm

Respironics Model 1118941
- Allows the user to attach a remote alarm to the **MACS epic**.



Remote Alarm Cables

MRI compatible BNC cables to attach the remote alarm to the **MACS epic**.

50 foot (15 m) cable
100 foot (30 m) cable





Bracket, Pole Mount

The Pole Mounting Bracket allows the **MACS epic** to be firmly attached to a vertical pole, such as an IV pole or a horizontal pole, such as a bedrail. Poles up to 1.25" (3 cm) can be accommodated. **MACS epic** slides in and out of the bracket that allows portable use.



Mobile Stand

- 3 foot, 9 inch (1.2 m) tall
- MRI compatible stand designed to hold the **MACS epic**. Two "E" size cylinders can be securely mounted on the stand. The unit attaches to the stand using a mounting plate, which allows the user to slide the **MACS epic** on and off the stand for transport.

	<p>Oxygen Regulator A MRI compatible high pressure oxygen regulator for D / E size oxygen tanks.</p>
	<p>Medical Air Regulator A MRI compatible high pressure air regulator for D / E size medical air tanks.</p>
	<p>High Pressure Oxygen Hose - DISS Female both ends, MRI compatible. (Note: ISO color hose available)</p>
	<p>Oxygen Cylinder E Size 650 liter MRI compatible</p> <p>D Size 400 liter cylinder with toggle valve</p>
	<p>Reusable Patient Circuit - Adult/pediatric patient circuit, autoclavable - 1.8 meters (6 ft)</p> <p>Available for International Customers Only.</p>

Section 7: Theory of Operation

MACS epic is a pneumatic device that provides Continuous Positive Airway Pressure (CPAP). It provides CPAP pressure up to 20 cm H₂O with inspiratory flow up to 140 L/min for a spontaneously breathing patient. This section describes how the device operates.

Further information on the device's theory of operation, including circuit diagrams, parts lists, and calibration instructions are available from Airon Corporation to properly trained service personnel.

Pneumatic System Diagram

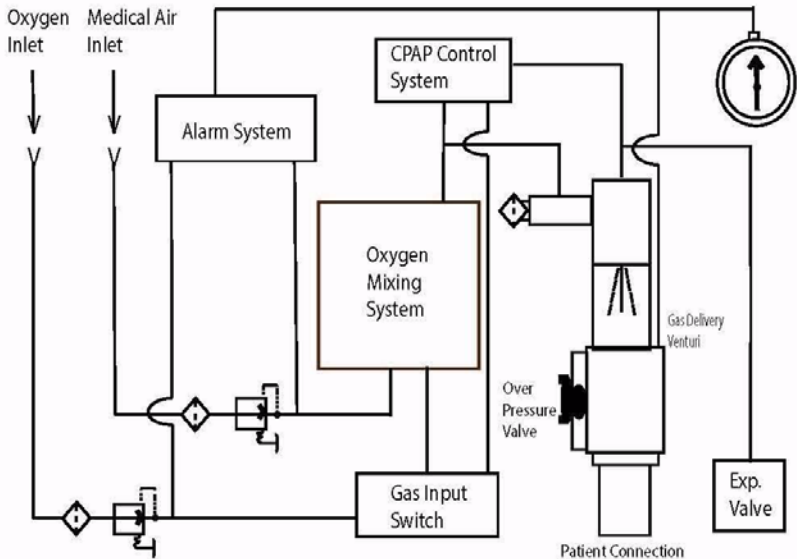

Pneumatic System Description

The major components of the pneumatic system and the control of gas flow through the device are as follows:

1. High pressure gas enters the device and is filtered (5 micron) and reduced to a lower working pressure (35 psi - 240 kPa).
2. The adjustable CPAP control system directs a pressure signal to the expiratory valve to generate CPAP and provides variable flow through the gas delivery venturi on demand for spontaneous breaths.
3. The Gas Input control is used to set the type of gas supply being used. When both oxygen and medical air are provided the control must be set for Oxygen + Air. If only oxygen is provided the control must be set for Oxygen Only.
4. When both oxygen and medical air are supplied the internal oxygen blender functions to deliver the F_{iO_2} as set by the % Oxygen control knob.
5. If only Oxygen is supplied (as in transport applications) the device then uses an internal venturi system, which provides 65% oxygen concentration.
6. If the Gas Input selector is not set correctly to match the actual supplied gas pressures an alarm will sound that cannot be silenced.

CPAP Demand Flow Breathing System

The device's internal CPAP demand flow system provides gas for spontaneous breathing at adjustable CPAP pressures up to 20 cm H₂O. This system has several key features:

1. When turned on, the system supplies a continuous flow of gas at approximately 10 L/min. This flow of gas helps to establish the desired CPAP level by balancing flow with the pressure generated on the

- expiratory valve by the CPAP system.
2. The continuous flow of gas also establishes the flow sensitivity to spontaneous breathing efforts. If the patient's inspiratory flow demand exceeds the continuous flow of gas, additional flow will be added to meet patient demand. There is no sensitivity adjustment to this system. The CPAP system will automatically meet the needs of the patient, with flows up to 140 L/min, by maintaining the balance between flow and pressure at the expiratory valve.
 3. The CPAP control is calibrated to the dynamics of Airon Corporation disposable patient circuit (part numbers 58001 through 58999). Using this circuit will ensure proper operation and the full 0 to 20 cm H₂O CPAP range.



WARNING: Using other patient circuits may affect operation and alter the device's CPAP characteristics and full CPAP range.

Oxygen Delivery System

When the device is driven by oxygen and compressed medical air as the source gases, the **MACS epic** delivers from 21% to 100% oxygen. When it is driven by oxygen alone the **MACS epic** delivers 65% oxygen. The Gas Input control must be set to match the gas supply or an alarm will sound.

Oxygen Delivery Accuracy

The F_IO₂ of this system is set by the combination of the Gas Input control and the % Oxygen control as described above. During operation the actual oxygen percentage and baseline flow is related to the level of CPAP in use. When set between 2 and 10 cm H₂O CPAP, the oxygen accuracy is within 10%. As the CPAP level increases to 20 cm H₂O, the oxygen delivery can be expected to increase to within 15% of the F_IO₂ setting. This is due to a drop off in efficiency

(stalling) of the CPAP venturi system at higher CPAP levels. Irrespective of the CPAP level set, patients with extremely high inspiratory flow demand (greater than 50 L/min) or high minute ventilation may decrease the delivered $F_{I}O_2$.

It is recommended that an external oxygen monitor be used to measure and display the delivered oxygen concentration.

Factors Effecting the Operating Time of Oxygen / Air Tanks

There are several factors that affect the length of time the device will operate from tanks of compressed gas. **MACS epic** uses very little gas for device operation (less than 20 ml/min) and is not a major factor in tank consumption. The major factors are:

- Volume of oxygen and air in the tanks
- Patient's tidal volume and rate (minute volume)
- Position of the Gas Input control and % Oxygen control
- Level of CPAP in use

Operating Time when using Oxygen Only

With the Gas Input control set for Oxygen Only the device delivers 65% oxygen. When CPAP is turned on, **MACS epic** uses approximately 5 L/min oxygen from the tank to provide the 10 L/min baseline flow of the system. The patient's own spontaneous tidal volume and rate will use additional oxygen from the tank, based upon the tidal volume of those breaths. Below are approximate operating times based on different combinations of patient tidal volume and rate, known as minute volume.

Approximate operating time using a full "D" size cylinder (400 liters) at 10 cm H₂O CPAP

<u>Minute Volume</u>	<u>65% Oxygen</u>
5 L/min	65 min
10 L/min	45 min
15 L/min	35 min

**Approximate operating time
using a full "E" size cylinder (660 liters)
at 10 cm H₂O CPAP**

<u>Minute Volume</u>	<u>65% Oxygen</u>
5 L/min	100 min
10 L/min	67 min
15 L/min	50 min

Operating Time when using Oxygen and Air

With the Gas Input control set for Oxygen + Air, the % Oxygen control determines the level of delivered oxygen. Under these conditions the internal blender is using gas from both the oxygen and medical air tanks to provide the set oxygen. At 10 cm H₂O CPAP the device uses approximately 17 L/min from the tanks to provide (1) the 10 L/min baseline flow of the system and (2) ensure accurate oxygen delivery. Based upon the % Oxygen setting more or less gas is used from each tank. Below is a table that shows how much gas is being drawn from the tanks depending on the % Oxygen control.

Tank consumption at 10 cm H₂O CPAP (L/min)

<u>% Oxygen</u>	<u>Oxygen tank usage</u>	<u>Air tank usage</u>
21	0 L/min	17 L/min
40	4 L/min	13 L/min
60	8.5 L/min	8.5 L/min
100	17 L/min	0 L/min

The above tank consumption is only to provide the baseline CPAP level of 10 cm H₂O. As the patient inspires, additional gas is used from the tanks. The following table estimates the operating time for a normal adult patient breathing at 10 L/min.

**Approximate operating time
using full "E" size cylinders (660 liters) for both
oxygen and medical air at 10 cm H₂O CPAP,
patient breathing at 10 L/min**

<u>% Oxygen</u>	<u>Time</u>
21	24 min
40	33 min
60	48 min
100	24 min

Disconnect Alarm

The **MACS epic** has an internal patient circuit disconnect alarm system. This system cannot be turned off. If a circuit disconnect is sensed, the visual indicator on the front panel will illuminate and the audible alarm will sound.

The alarm will activate as soon as a gas source is supplied to the device. Attaching the device to a patient and starting CPAP will automatically reset the alarm system and turn off the audible and visual indicators.

A patient circuit disconnect is sensed if the pressure in the patient circuit is less than 5 cm H₂O for 22 seconds. If the CPAP pressure is at 5 cm H₂O or greater the alarm is deactivated, monitoring for a low pressure condition to occur.

The alarm system can be momentarily silenced by pressing the Reset / Silence button on the front panel. Pressing this button turns off the visual and audible indicators for 60 seconds. Each time the Reset / Silence button is pressed; the alarm system restarts the 60 second silence time delay. This delay is NOT cumulative. In other words, repeatable pressing of the Reset / Silence button will not increase the silence time by more than 60 seconds.

The alarm system is entirely pneumatic and uses no electricity. A series of valves and pneumatic capacitances provide the sensing network. Due to the nature of this system, a minimum CPAP of 5 cm H₂O is required. If CPAP is set for less than 5 cm H₂O the alarm system will activate.

The alarm system provides a passive, non-electrically charged remote alarm output on the rear panel of the **MACS epic**. The remote output uses a normally closed signal output with a resistance of 51K Ohms. When an alarm occurs, the signal output opens to infinite resistance. This is a passive remote alarm output that does not provide its own electrical signal. Use the Airon Remote Alarm (Part number 21031) to provide a remote audible and visual indication of active alarm conditions.

Low Gas Supply Alarm

The **MACS epic** has a Low Gas Supply Alarm when using the internal oxygen blender (Gas Input control set for Oxygen + Air). This alarm will occur if either driving gas supply (Air or Oxygen) drops below safe levels for accurate gas mixing. The alarm activates as long as either driving gas is available or until the supply pressure returns to normal. The silence button will not stop this alarm.



CAUTION: When using only oxygen as a source gas during transport (Gas Input control set for Oxygen only) there is no Low Gas Supply Alarm if the oxygen supply pressure is lost.

The Low Gas Supply Alarm monitors the differential pressure between the two gas supplies within the blender. The alarm occurs if the pressure differential between the air and oxygen sources to the blender reaches approximately 18-22 psi (125-150 kPa) or more. During this alarm

condition the **MACS epic** will continue to operate normally but the gas delivered will be 100% of whatever gas supply is at the higher pressure.

While operating from cylinders the device will gradually use up the gas supply and tank pressures will fall. Once one of the cylinders reaches approximately 500 psi (35 bar), most portable tank regulators will start to decrease output pressure during demand. As this happens the Low Gas Supply Alarm will sense the increased pressure differential and begin to intermittently alarm each time the pressure drops during patient inspiration. As pressure in the cylinder falls to lower values, the amount of time the regulator is delivering low pressure increases and the alarm sounds longer. Eventually the regulator is unable to maintain pressure and the alarm will sound continuously until all gas in both cylinders is used.



WARNING: The Low Gas Supply Alarm will only activate for a very short period of time if the gas supply abruptly ceases. This can occur if operating from a wall source and the gas supply hoses are disconnected from the gas supply outlet. In fact, the Low Gas Supply Alarm may not sound at all when the device is disconnected from a wall source. This is because all gas in the high pressure hose immediately exits out from where the hose was connected to the outlet and there is no gas pressure to power the device's alarm. When using the **MACS epic** on a patient always insure that the supply gas is secure and operating at the proper pressure.

Section 8: Troubleshooting

This troubleshooting guide lists common problems that may be encountered and possible solutions. If none of the corrective actions seem to work, contact Airon Corporation or your distributor.

Indication	Meaning	Corrective Action
Device does not operate – no gas flow	Missing or insufficient driving gas supply	Check gas source, 55 psi (380 kPa) at 40 L/min is required
	Patient circuit disconnection	Reconnect patient circuit
	Internal Malfunction	Send device for service
Device seems to “want” to operate, but little gas flow is available	Expiratory Valve drive line disconnected	Ensure tubing is properly connected
	Expiratory Valve is malfunctioning	Replace Patient Circuit
	Insufficient driving gas supply	Check gas source, 55 psi (380 kPa) at 40 L/min is required
	Internal Malfunction	Send device for service
Device appears to be stuck with high flow	CPAP may be turned on high	Check CPAP control
	Expiratory valve drive line disconnected	Ensure tubing is properly connected
	Patient circuit disconnection	Reconnect patient circuit
	Internal Malfunction	Send device for service
Can't get the CPAP desired	Expiratory Valve malfunctioning	Replace patient circuit with Airon part number 58011
	Using a circuit not recommended by Airon	Replace patient circuit with Airon part number 58011

Indication	Meaning	Corrective Action
Can't get the CPAP desired (cont.)	Internal malfunction	Send device for service
	Excessive "chattering" of CPAP system	Occurs when using some test lungs but will not occur when connected to a patient. If problem persists, send device for service
Alarm activated	Gas Input control not set to match gas supplies	Gas Input must be set for Oxygen + Air (up) when both gases are supplied. Gas Input must be set for Oxygen Only (down) if only oxygen is supplied.
	Gas supply too low	When the Gas Input is set for Oxygen + Air, one gas supply pressure is too low
	Patient circuit disconnection	Reconnect patient circuit
	Internal Malfunction	Send device for service
Device using too much gas	Leak at gas source	Check hoses and tank regulator for leaks
	Internal leaks	Send device for service
Measured oxygen concentration too low	Patient circuit disconnection	Oxygen must be measured during normal or simulated breathing. Measurements without CPAP in the circuit and normal breaths will be erroneous
	Source gas not 100% oxygen	Ensure source gas is 100% oxygen

Indication	Meaning	Corrective Action
	High patient spontaneous ventilation	Calm patient, decrease spontaneous ventilation
	Internal malfunction	Send device for service
Visual alarm activates but audible does not	Internal malfunction	Send device for service

Section 9: Cleaning and Maintenance



Cleaning the Device

- Use only mild detergent or disinfectant and water with a soft cloth.
- Do not immerse the device in water.
- Do not attempt to sterilize the device with autoclave or ethylene oxide. Severe damage to the device may occur.

Cleaning / Disinfecting the Patient Circuit

The recommended Airon patient circuit is a disposable, single use device, Airon part number 58001 through 58999. This circuit must not be cleaned, disinfected or reused. See Single-Use only Medical Device information, page 5-3.

Routine Maintenance

Airon Corporation recommends that an Operational Verification Test (see Section 4) be performed with initial installation and prior to use on each patient. Institution's standards may require additional biomedical surveillance. No additional routine maintenance is required.



Factory Preventative Maintenance

- Device service is required every 2 years to ensure continuous safety and reliability of the device.
- Device service includes:
 - Replacement of internal and external filters
 - Replacement of internal materials subject to wear
 - Reconditioning of the enclosure
 - Complete calibration

- This service must only be performed by Airon Corporation or an Airon approved service technician.
- Failure to perform this service may result in malfunctioning of the device.

Section 10: Specifications

General Description

- Pneumatically operated device provides CPAP using a demand flow system
- Equipment not suitable for use in the presence of flammable anesthetics
- Rated for continuous operation

System Performance

- Controls
 - CPAP 0 to 20 cm H₂O
 - % Oxygen 21% to 100% or 65%
- Operating Ranges
 - Internal P Limit 42 cm H₂O
- Accuracy of Controls
 - CPAP $\pm 5\%$
 - F_IO₂ $\pm 10\%$
- Precision - breath to breath repeatability of controls
 - CPAP ± 2 cm H₂O
 - F_IO₂ $\pm 5\%$
- Specificity - effect of one control on another
 - CPAP $\pm 5\%$
 - F_IO₂ $\pm 5\%$
- Internal Compliance 0.1 ml/cm H₂O
- Device Resistance to Flow
 - Inspiratory, 60 L/min: less than 2 cm H₂O
 - Expiratory, 50 L/min: less than 2 cm H₂O

Alarm System

- Patient Disconnect
 - CPAP pressure: less than 5 cm H₂O
 - Alarm delay: 22 seconds
 - Alarm silence: 60 seconds
- Low Gas Supply – Gas Input Oxygen + Air only
 - Input supply pressure differential: 18 to 22 psi (1.2 to 1.5 bar) or more
 - Cannot be silenced

Environmental and Physical Characteristics

- Hypobaric (high altitude) compatible up to 15,000 feet (4,600 meters)
- Weight: 6.0 pounds (2.7 kg)
- Size: 7.5"H x 6.0"W x 8.7"D (19.1 cm x 15.2 cm x 22.1 cm)
- Storage Temperature Range: -46 to 71 °C (-51 to 160 °F), 15 to 95 percent humidity, noncondensing
- Operating Temperature Range: -26 to 60 °C (-15 to 140 °F), 15 to 95 percent humidity, noncondensing

Power Sources

- Driving gas requirement
 - 55 psi \pm 15 psi (380 kPa \pm 100 kPa)
 - Oxygen and compressed medical grade air. Do not use the device with other types of gases.
 - The gas supply must be capable of delivering at least 40 liters per minute at 55 psi. If input pressure drops less than 40 psi due to insufficient gas flow, the device will begin to malfunction.

NOTE: Baseline oxygen consumption at 10 cm H₂O CPAP;
Gas Input set for Oxygen Only: 5 L/min
Gas Input set for Oxygen + Air: 17 L/min

Section 11: Limited Warranty

AIRON CORPORATION, through its Official Distributor, warrants this product to be free from defects in construction, material and workmanship for a period of twelve (12) months from the date of original delivery to buyer when operated properly under conditions of normal use for which the product is intended. This twelve (12) month warranty does not extend to expendable items such as membranes, hoses, patient circuits and filters which are warranted to be free of defects only at time of original delivery.

The official AIRON CORPORATION Distributor will, at its option, either repair or replace any defective product, as above defined, which is reported to that AIRON CORPORATION Distributor within 72 hours of occurrence during the warranty period. If so instructed by the Distributor, such defective products must be returned to the official AIRON CORPORATION Distributor in the original container with freight charges prepaid. In any case, AIRON CORPORATION shall be responsible for repairs to, or replacement of, such defective product only.

LIMITATIONS ON AND DISCLAIMER OF WARRANTIES:

AIRON CORPORATION shall be relieved of any liability under this warranty: if the product is not used in accordance with manufacturer's instructions; if attachment or incorporation of any device is made to this product without written approval; if use is made in any manner other than intended by the manufacturer; if regular periodic maintenance and service is not performed; if repairs are made by other than authorized AIRON CORPORATION service personnel; if the product has been subject to abuse, misuse, negligence or accident. Any product that has been mechanically or electronically altered without specific written authorization from AIRON CORPORATION is also excluded

from this warranty.

The warranty described in this Agreement is in lieu of all other warranties. THE PARTIES AGREE THAT THE IMPLIED WARRANTIES OF MERCHANTABILITY AND FITNESS FOR A PARTICULAR PURPOSE AND ALL OTHER WARRANTIES, EXPRESS OR IMPLIED, ARE EXCLUDED FROM THIS AGREEMENT.

Except as stated above, AIRON CORPORATION SHALL NOT BE LIABLE FOR ANY DAMAGES, CLAIMS OR LIABILITIES INCLUDING, BUT NOT LIMITED TO, PERSONAL BODILY INJURY, OR INCIDENTAL, CONSEQUENTIAL, OR SPECIAL DAMAGES.

Section 12: Index

A

- Accessories 6-1
- Airway Connection Port 3-3
- Alarms
 - Disconnect 3-7, 4-4, 7-6
 - Low Gas Supply 3-6, 7-7
- Altitude Operation 4-5

C

- Cautions 2-3
- Circuit, Patient Breathing
 - Cleaning 9-1
 - Configuration 5-1
 - Connecting 5-2
 - Set-up 4-3
- Cleaning 9-1
- Contraindications 1-2
- Controls
 - % Oxygen 3-2
 - CPAP 3-2
- CPAP
 - Control 3-2
 - Functional Operation 7-2
 - Trigger Sensitivity 7-2

D

- Device set-up 4-1
- Disconnect Alarm 3-7, 4-4

E

- Expiratory Valve
 - Connection 5-2
 - Relationship to CPAP System 7-2

F

- Front Panel 3-1

H

Hypobaric Operation 4-5

I

Indications For Use 1-1

Internal Patient Safety Systems 3-6

M

Maintenance - Device Service 9-1

Medical Symbol Key 2-5

N

Notes 2-3

O

Operating Instructions 4-1

Operational Verification 4-2

Oxygen

 % Oxygen Control 3-2

 Driving Gas Inlet 3-4

 Driving Supply Requirements 10-2

 Operational Characteristics 7-3

 Oxygen Control, Set-up 4-4

P

Patient Circuit

 Cleaning 9-1

 Configuration 5-1

 Connecting 5-2

 Set-up 4-1

Performance Verification 4-2

Pneumatic System 7-2

Power Requirements - Driving Gas Supply 10-2

Pressure - CPAP Control 3-2

Pressure Gauge 3-1

Preventative Maintenance 9-1

Principles of Operation

 CPAP Demand Flow Breathing System 7-2

 Oxygen Delivery System 7-3

Pneumatic System Diagram 7-1
Pneumatic System Description 7-2

R

Rear Panel 3-3
Routine Maintenance 9-1

S

Safety Systems 3-6
Sensitivity 7-3
Set-up 4-1
Service 9-1
Single-Use only Devices/Accessories 5-3
Specifications
 Alarm System 10-2
 Environmental and Physical Characteristics 10-2
 General Description 10-1
 Power Sources 10-2
 System Performance 10-1
Spontaneous Breaths
 $F_{I}O_2$ 7-3
 Peak Flow 7-2

T

Theory of Operation
 CPAP Demand Flow Breathing System 7-2
 Disconnect Alarm 7-6
 Low Gas Supply Alarm 7-7
 Oxygen Delivery System 7-3
 Pneumatic System Diagram 7-1
 Pneumatic System Description 7-2
Troubleshooting 8-1

U

Unique Device Identifier (UDI) 3-5

V

Verification, Operating 4-1

W

Warnings 2-1